

GENERAL FEATURES

Applications	Direct View, Accent, Decorative Lighting
Lens	Clear, 50% Semi-Frosted, or 100% Frosted
Viewing Angle	120°
Length	Built to Order (+/- 1/8" Tolerance)
Construction	Aluminum Extrusion
Field Cutting	Dry Location Only
Weight	0.264 lbs per foot
Mounting	Glass Mount (Adhesive)
Listing	Dry, Wet, or IP67 Location UL2108, 67.1.9, 60.4, CSA C22.2 #9 UL8750, CSA250
Driver	Remote (Sold Separately)
Closet Rating	Up to 3.6 Watts per Foot Maximum
Temperature Ratings	Operating / Startup: -20° to 48°C (-4° to 120°F) Storage: -40° to 76°C (-40° to 170°F)
Installation Link	

END VIEWS / DIMENSIONS

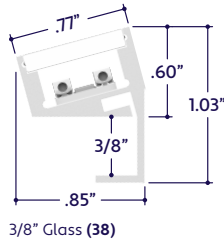
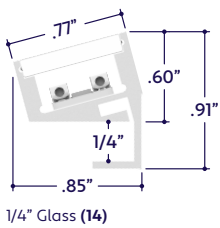

MOUNTING OPTION

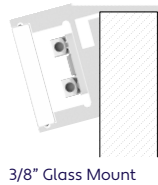
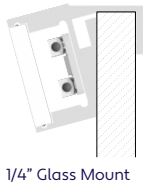

ELECTRICAL

Dimming	0-10V, Forward / Reverse Phase, Lutron, DMX, DALI
Maximum Run (Class 1 Applications)	20' (6W), 30' (4W), 36' (3W, 2W)
Maximum Run (Class 2 Applications)	14' (6W), 21' (4W), 28' (3W), 36' (2W)
Luminaire Voltage	24VDC

SPECIFY PRODUCT CODE | CHOOSE FROM DROP DOWNS

Series	Glass Size	Lens	Watts per Foot	Dimming	CCT LED	Listing	Finish	Luminaire Length
A1-ZAKY-GLS								
ZAKY Standard (A1-ZAKY-GLS)	1/4" Glass (14) 3/8" Glass (38)	Clear Lens (CL)	2 Watts (2W) 216 Lumens / ft*	0-10V: 100% - 1% (10V)	2400K (24K)	Indoor (DRY)	Natural Silver* (NA)	Specify Length in Feet & Inches Example: 7'8"
			3 Watts (3W) 324 Lumens / ft*	Phase Dimming: Forward Phase / Reverse Phase (PH)	2700K (27K)		Polished (PA)	
	50% Semi-Frosted Lens (SF)	3 Watts (3W) 324 Lumens / ft*	Hi-Lume 1% 3 Wire* (L3DA)	3000K (30K)	Outdoor* (WET)	White (WH)		
		4 Watts (4W) 432 Lumens / ft*	Hi-Lume Premier 0.1% JA8* (L3D0)	3500K (35K)		Satin / Silver (SA)		
	100% Frosted Lens: Line of Light (F)	6 Watts (6W) 648 Lumens / ft*	DALI* (DALI)	DMX-512* (DMX)	4000K (40K)	Outdoor IP67* (IP67)	Black (BK)	
				JAB 0-10V (JA8-10V)	4500K (45K)			
	Leave Blank for Non-Dimming					5000K (50K)		
						5700K (57K)		
						Red (R)		
						Green (G)		
					Blue (B)			
					Amber (A)			

Note: Remote drivers wattage sized based on length of run. **Example:** 10' run x 3 Watts per foot = 30 Watts. Driver will be sized to 30 Watts maximum.

- * Lumens per Foot based on 35K CCT LED with Clear Lens (CL). **Example:** 108 Lumens x 2 Watts = 216 Lumens per Foot.
- ** (L3DA) 40 watt max Hi-Lume 1% L3DA3W #L3DA4U1UKL-CV240
- ** (L3D0) 96 watt max Hi-Lume Premier 0.1% #L3D0-96W24V-U
- ** Default DMX address of each fixture is 001. Consult third party DMX commissioner to modify at time of installation.
- ** DALI commissioning to be performed by a third party at time of installation. ALUZ does not provide DALI commissioning.
- ** Run lengths required for Wet Location and IP67 products. Provide run lengths at time of order.
- ** Standard Finish is Natural Silver (NA) if left blank.



LAMP FEATURES

Lamp Type	LEDs
CRI	> 90
Efficacy (Based on 35K CCT LED)	108 Lumens per Watt

LAMP SPECIFICATIONS

Lamp Number	Correlated Color Temperature / Description	Efficacy (Lumens per Watt)	L70 LED Life
24K	2400 Kelvin (Incandescent White)	108	60,000 hrs.
27K	2700 Kelvin (Warm White)	108	
30K	3000 Kelvin (Warm White)	108	
35K	3500 Kelvin (Neutral White)	108	
40K	4000 Kelvin (Neutral White)	108	
45K	4500 Kelvin (Neutral White)	108	40,000 hrs.
50K	5000 Kelvin (Cool White)	108	
57K	5700 Kelvin (Cool White)	108	
R	Red (621nm)		
G	Green (525nm)		
B	Blue (470nm)		
A	Amber (590nm)		

To calculate Lumens per Foot, multiply Efficacy by Watts per Foot.
Example: 108 Lumens per Watt x 2 Watts per Foot = 216 Lumens per Foot.

LENS / OPTICS APPEARANCE



Clear Lens (CL)
Visible Diode Image
0% Light Loss



50% Semi-Frosted Lens (SF)
Slight Diode Image
12.5% Light Loss



100% Frosted Lens (F)
No Diode Image: Line of Light
25% Light Loss

BEAM ANGLE

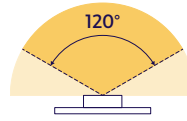

120° x 120° Beam

SPECTRAL POWER DISTRIBUTION AMBER LED (590nm) TURTLE FRIENDLY

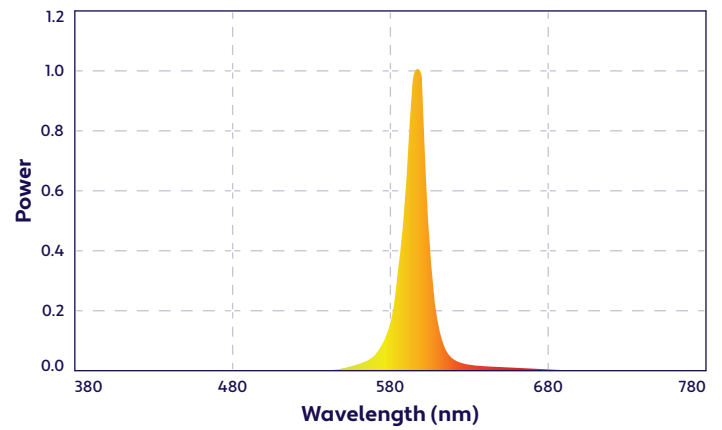

DRIVERS

Dimming Selection	Product Code	Link to Specification Sheet / URL
Phase Dimming: Forward Phase / Reverse Phase	(PH)	
0-10V: 100% - 1%	(10V)	
Hi-Lume 1% 3 Wire	(L3DA)	
Hi-Lume Premier 0.1% JA8	(L3D0)	
JA8 0-10V	(JA8-10V)	
DMX-512	(DMX)	
DALI	(DALI)	

END CAPS & CHANNEL CLIP (Sold Separately)

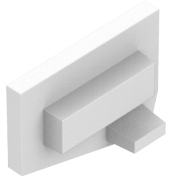

Left End Cap
 (A1-ZAKY-GLS-ECL)

Part #	Qty.
A1-ZAKY-GLS-ECVCL	

Note: Use 1 Right End Cap for each left termination.

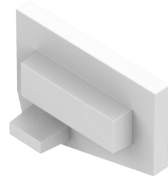

Right End Cap
 (A1-ZAKY-GLS-ECR)

Part #	Qty.
A1-ZAKY-GLS-ECR	

Note: Use 1 Right End Cap for each right termination.



Channel Clip
 (A1-ZAKY-GLS-CP)

Part #	Qty.
A1-ZAKY-GLS-CP	

Note: Use 1 Channel Clip every 6" for downward facing, outward facing, or vertically mounted applications.

DRY CONNECTORS (Sold Separately)

Note: Connectors are factory assembled to each run length. Connectors are subject to change without notice.



Dry Power Connector
(A1-ZAKY-GLS-PC-SFF-DRY-X)
X = Specify Length, 36" Default, 25' Maximum

Part #	Length	Qty.
A1-ZAKY-GLS-PC-SFF-DRY-	36"	
A1-ZAKY-GLS-PC-SFF-DRY-		

Note: Specify 1 Power Connector for each lead required. Power Connectors are factory assembled to each length.



Dry Power Connector with Black Jacket
(A1-ZAKY-GLS-PC-SFF-DRY-BK-X)
X = Specify Length, 36" Default, 25' Maximum

Part #	Length	Qty.
A1-ZAKY-GLS-PC-SFF-DRY-BK-	36"	
A1-ZAKY-GLS-PC-SFF-DRY-BK-		

Note: Specify 1 Power Connector for each lead required. Power Connectors are factory assembled to each length.



Dry Power Connector with White Jacket
(A1-ZAKY-GLS-PC-SFF-DRY-WH-X)
X = Specify Length, 36" Default, 25' Maximum

Part #	Length	Qty.
A1-ZAKY-GLS-PC-SFF-DRY-WH-	36"	
A1-ZAKY-GLS-PC-SFF-DRY-WH-		

Note: Specify 1 Power Connector for each lead required. Power Connectors are factory assembled to each length.

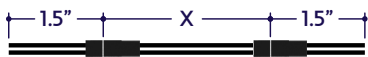
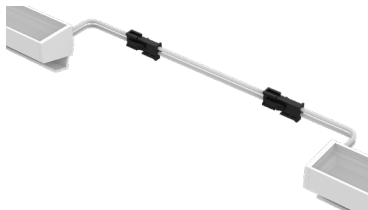

Dry Continuous Connector
(A1-ZAKY-GLS-CC-SFF-DRY-X)
X = Specify Length, 3" Default

Part #	Length	Qty.
A1-ZAKY-GLS-CC-SFF-DRY-	3"	
A1-ZAKY-GLS-CC-SFF-DRY-		

Note: Specify Continuous Connectors to traverse a gap or obstacle. Continuous Connectors are factory assembled to specified lengths.



Dry Continuous Connector with Black Jacket
(A1-ZAKY-GLS-CC-SFF-DRY-BK-X)
X = Specify Length, 3" Default

Part #	Length	Qty.
A1-ZAKY-GLS-CC-SFF-DRY-BK-	3"	
A1-ZAKY-GLS-CC-SFF-DRY-BK-		

Note: Specify Continuous Connectors to traverse a gap or obstacle. Continuous Connectors are factory assembled to specified lengths.

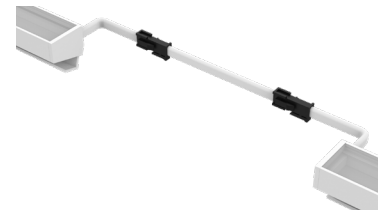

Dry Continuous Connector with White Jacket
(A1-ZAKY-GLS-CC-SFF-DRY-WH-X)
X = Specify Length, 3" Default

Part #	Length	Qty.
A1-ZAKY-GLS-CC-SFF-DRY-WH-	3"	
A1-ZAKY-GLS-CC-SFF-DRY-WH-		

Note: Specify Continuous Connectors to traverse a gap or obstacle. Continuous Connectors are factory assembled to specified lengths.

WET CONNECTORS (Sold Separately)

Note: Connectors are factory assembled to each run length. Connectors are subject to change without notice.



Wet Power Connector
(A1-ZAKY-GLS-PC-SFF-WET-X)
X = Specify Length, 36" Default, 25' Maximum

Part #	Length	Qty.
A1-ZAKY-GLS-PC-SFF-WET-	36"	
A1-ZAKY-GLS-PC-SFF-WET-		

Note: Specify 1 Power Connector for each lead required. Power Connectors are factory assembled to each length.



Wet Continuous Connector
(A1-ZAKY-GLS-CC-SFF-WET-X)
X = Specify Length, 3" Default

Part #	Length	Qty.
A1-ZAKY-GLS-CC-SFF-WET-	3"	
A1-ZAKY-GLS-CC-SFF-WET-		

Note: Specify Continuous Connectors to traverse a gap or obstacle. Continuous Connectors are factory assembled to specified lengths.

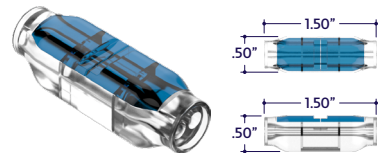

Part #	Qty.
A1-SC-2P-WET	

DESIGN GUIDELINES

Individual Fixture

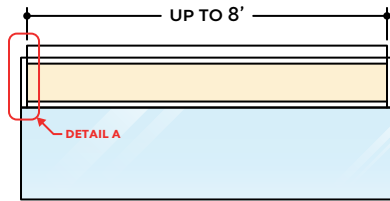

Continuous Run (Dry Location)

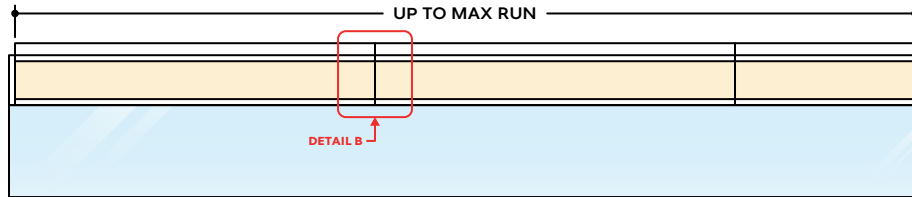

Continuous Run (Wet Location)

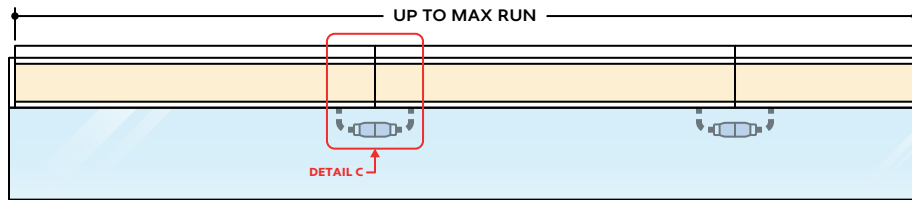

Runs with Continuous Connector (Dry Location)

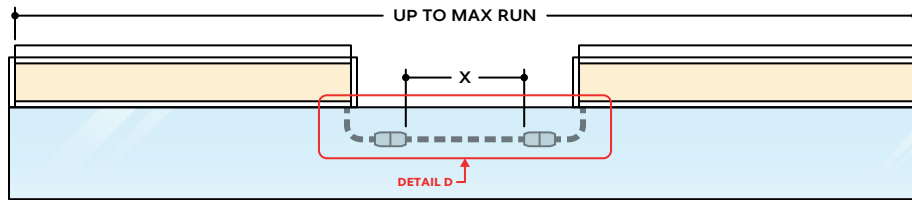

Runs with Continuous Connector (Wet Location)

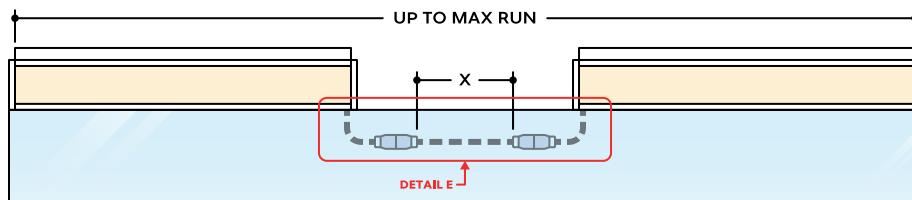

KEY

- Detail A** **End Cap:** Used to terminate each end of a run.
- Detail B** **Continuous Connection (Dry Location):** Luminaire segments connect using pins, leaving no gaps between segments, with a mounting clip holding the two segments together. Refer to installation instructions for additional information.
- Detail C** **Continuous Connection (Wet Location):** Luminaire segments are connected using a provided back-fed splice connector, with no gap between segments.
- Detail D** **Dry Continuous Connector:** Used to span a corner or traverse a gap, corner, or obstacle in a dry location installation area.
- Detail E** **Wet Continuous Connector:** Used to span a corner or traverse a gap, corner, or obstacle in a wet location installation area.

Note: Drawings not to scale. Product may differ from examples shown.

CONNECTION SEQUENCE

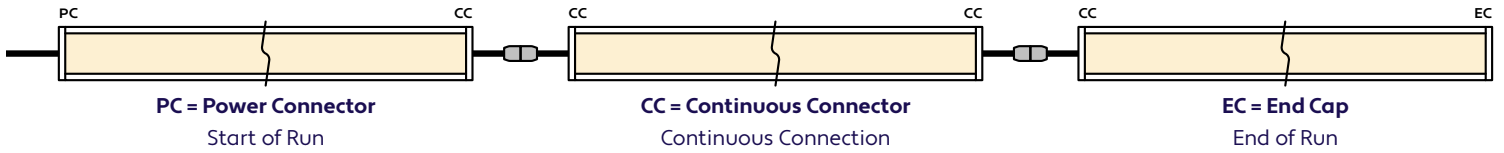

- Specifying a layout is not required to place an order.
- Configuration code applies to full length ordered and will be built per the Continuous Run models on Design Guidelines.
- Connector type subject to change based on availability and listing. Refer to Design Guidelines for details.

HOW TO SPECIFY CONFIGURATIONS

Example: 20' Straight Run

- 1x A1-ZAKY-GLS-14-CL-2W-10V-35K-DRY-NA-20'-PC-EC

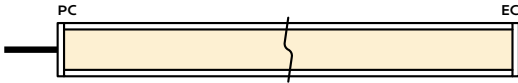

Example: 25' L-Shaped Run

- 1x A1-ZAKY-GLS-14-CL-2W-10V-35K-WET-NA-12'-PC-CC
- 1x A1-ZAKY-GLS-14-CL-2W-10V-35K-WET-NA-6'-CC-EC

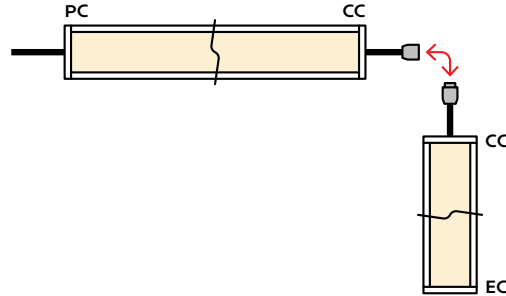

Example: 30' U-Shaped Run

- 1x A1-ZAKY-GLS-14-CL-2W-10V-35K-DRY-NA-6'-PC-CC
- 1x A1-ZAKY-GLS-14-CL-2W-10V-35K-DRY-NA-18'-CC-CC
- 1x A1-ZAKY-GLS-14-CL-2W-10V-35K-DRY-NA-6'-CC-EC

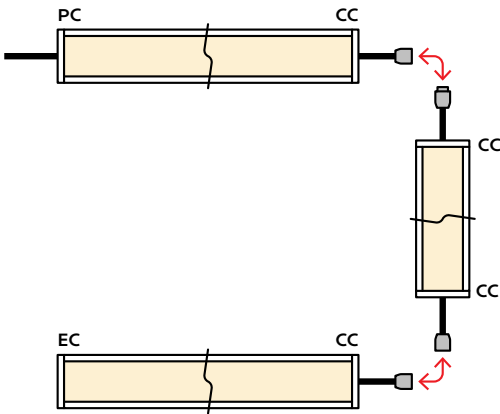

Example: 28' Rectangle Shaped Run

- 1x A1-ZAKY-GLS-14-CL-2W-10V-35K-WET-NA-11'-PC-CC
- 1x A1-ZAKY-GLS-14-CL-2W-10V-35K-WET-NA-3'-CC-CC
- 1x A1-ZAKY-GLS-14-CL-2W-10V-35K-WET-NA-11'-CC-CC
- 1x A1-ZAKY-GLS-14-CL-2W-10V-35K-WET-NA-3'-CC-EC

