

END VIEW / DIMENSIONS

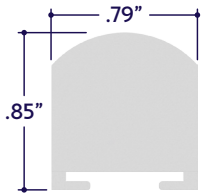

LENS / OPTICS APPEARANCE



100% Frosted Lens (F)
No Diode Image: Line of Light
25% Loss Factor

GENERAL FEATURES

Applications	Accent, Decorative, Surface, Recessed, Pendant Lighting
Lens	100% Frosted: No Pixelation (Line of Light)
Length	Built to Order (+/- 1/8" Tolerance)
Construction	Aluminum Extrusion
Field Cutting	Dry Location Only
Weight	0.35 lbs per Foot
Mounting	Mounting Clips (Sold Separately)
Listing	Dry, Wet, or IP67 Location UL1598, CSA C22.2#250.0 UL8750, CSA250 UL2108, 67.1.9, 60.4, CSA C22.2 #9
Driver	Remote
Closet Rating	Up to 3.6 Watts per Foot Maximum
Temperature Ratings	Operating / Startup: -20° to 48°C (-4° to 120°F) Storage: -40° to 76°C (-40° to 170°F)
Installation Link	

ELECTRICAL

Dimming	0-10V, Forward / Reverse Phase, Lutron, DMX, DALI
Maximum Run (Class 1 Applications)	22' (5.3W), 27' (4.3W), 36' (3.3W)
Maximum Run (Class 2 Applications)	16' (5.3W), 19' (4.3W), 25' (3.3W)
Luminaire Voltage	24VDC

SPECIFY PRODUCT CODE | CHOOSE FROM DROP DOWNS

Series	Watts per Foot	Dimming	CCT LED	Listing	Finish	Luminaire Length
A1-ZAKY-SFR						
ZAKY Standard Frosted (A1-ZAKY-SFR)	3.3 Watts (3.3W) 356 Lumens / ft*	0-10V: 100% - 1% (10V)	2400K (24K)	Indoor (DRY)	Natural Silver* ⁷ (NA)	Specify Length in Feet & Inches Example: 127"
	4.3 Watts (4.3W) 464 Lumens / ft*	Phase Dimming: Forward Phase / Reverse Phase (PH)	2700K (27K)	Outdoor* ⁶ (WET)	Polished (PA)	
	5.3 Watts (5.3W) 572 Lumens / ft*	Hi-Lume 1% 3 Wire* ² (L3DA)	3000K (30K)	Outdoor IP67* ⁶ (IP67)	White (WH)	
		Hi-Lume Premier 0.1% JA8* ³ (L3D0)	3500K (35K)		Satin / Silver (SA)	
		DMX-512* ⁴ (DMX)	4000K (40K)		Black (BK)	
		DALI* ⁵ (DALI)	4500K (45K)			
		JAB 0-10V (JA8-10V)	5000K (50K)			
		Leave Blank for Non-Dimming	5700K (57K)			
			6500K (65K)			

Note: Remote drivers wattage sized based on length of run. **Example:** 10' run x 3 Watts per foot = 30 Watts. Driver will be sized to 30 Watts maximum.

- *¹ Lumens per Foot based on 35K CCT LED. **Example:** 108 Lumens x 2 Watts = 216 Lumens per Foot.
- *² (L3DA) 40 watt max Hi-Lume 1% L3DA3W #L3DA4UIUKL-CV240
- *³ (L3D0) 96 watt max Hi-Lume Premier 0.1% #L3D0-96W24V-U
- *⁴ Default DMX address of each fixture is 001. Consult third party DMX commissioner to modify at time of installation.
- *⁵ DALI commissioning to be performed by a third party at time of installation. ALUZ does not provide DALI commissioning.
- *⁶ Run lengths required for Wet Location and IP67 products. Provide run lengths at time of order.
- *⁷ Standard Finish is Natural Silver (NA) if left blank.

LAMP FEATURES

Lamp Type	LEDs
CRI	> 90
Efficacy (Based on 35K CCT LED)	108 Lumens per Watt

LAMP SPECIFICATIONS

Lamp Number	Correlated Color Temperature / Description	Efficacy (Lumens per Watt)	L70 LED Life
24K	2400 Kelvin (Incandescent White)	108	
27K	2700 Kelvin (Warm White)	108	
30K	3000 Kelvin (Warm White)	108	
35K	3500 Kelvin (Neutral White)	108	
40K	4000 Kelvin (Neutral White)	108	60,000 hrs.
45K	4500 Kelvin (Neutral White)	108	
50K	5000 Kelvin (Cool White)	108	
57K	5700 Kelvin (Cool White)	108	
65K	6500 Kelvin (Cool White)	108	

To calculate Lumens per Foot, multiply Efficacy by Watts per Foot.
Example: 108 Lumens per Watt x 3.3 Watts per Foot = 356 Lumens per Foot.

BEAM ANGLE

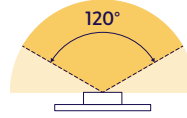

120° x 120° Beam

SPECTRAL POWER DISTRIBUTION AMBER LED (590nm) TURTLE FRIENDLY

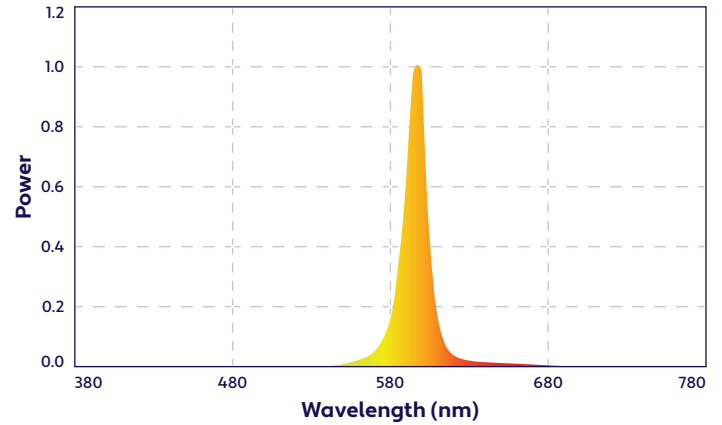

DRIVERS

Dimming Selection	Product Code	Link to Specification Sheet / URL
Phase Dimming: Forward Phase / Reverse Phase	(PH)	
0-10V: 100% - 1%	(10V)	
Hi-Lume 1% 3 Wire	(L3DA)	
Hi-Lume Premier 0.1% JA8	(L3D0)	
JA8 0-10V	(JA8-10V)	
DMX-512	(DMX)	
DALI	(DALI)	

MOUNTING OPTIONS (Sold Separately)

Note: Mounting clips are only available in Natural Silver Finish, unless otherwise specified.

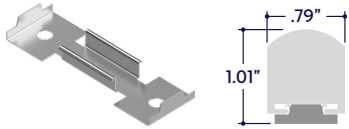

Part #	Qty.
A1-ZAKY-SFR-MC	

Note: Use 1 mounting clip per 2', rounded up. Click on image to see cut sheet for details.

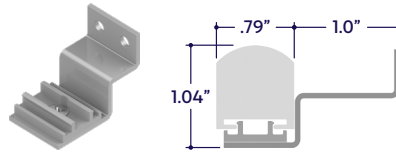

Part #	Qty.
A1-ZAKY-SFR-MC-2	

Note: Use 1 mounting clip per 2', rounded up. Click on image to see cut sheet for details.

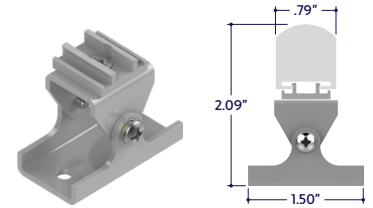

Part #	Qty.
A1-ZAKY-SFR-MC-3	

Note: Use 1 mounting clip per 2', rounded up. Click on image to see cut sheet for details.

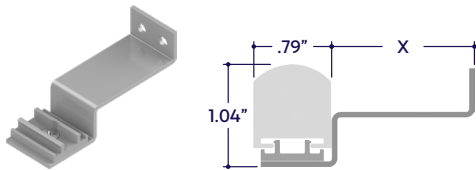

Part #	Length	Qty.
A1-ZAKY-SFR-MC-4-		

Note: Use 1 mounting clip per 2', rounded up. Click on image to see cut sheet for details.

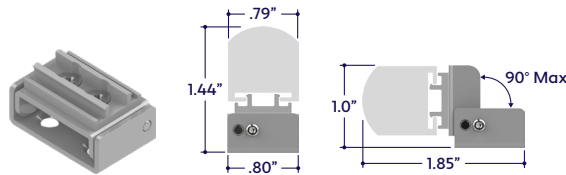

Part #	Qty.
A1-ZAKY-SFR-MC-ADJ	

Note: Use 1 mounting clip per 2', rounded up. Click on image to see cut sheet for details.

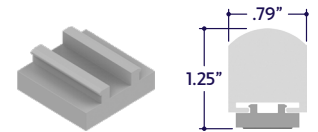

Part #	Qty.
A1-ZAKY-SFR-MC-MM	

Note: Use 1 mounting clip per 2', rounded up. Click on image to see cut sheet for details.

DRY CONNECTORS (Sold Separately)

Note: Connectors are factory assembled to each run length. Connectors are subject to change without notice.



Dry Power Connector
(A1-ZAKY-SFR-PC-DRY-X)
X = Specify Length, 36" Default, 25' Maximum

Part #	Length	Qty.
A1-ZAKY-SFR-PC-DRY-	36"	
A1-ZAKY-SFR-PC-DRY-		

Note: Specify 1 Power Connector for each lead required. Power Connectors are factory assembled to each length.

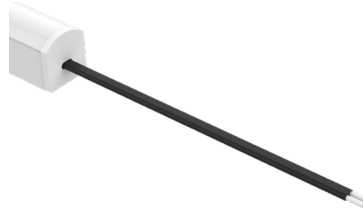

Dry Power Connector with Black Jacket
(A1-ZAKY-SFR-PC-DRY-BK-X)
X = Specify Length, 36" Default, 25' Maximum

Part #	Length	Qty.
A1-ZAKY-SFR-PC-DRY-BK-	36"	
A1-ZAKY-SFR-PC-DRY-BK-		

Note: Specify 1 Power Connector for each lead required. Power Connectors are factory assembled to each length.

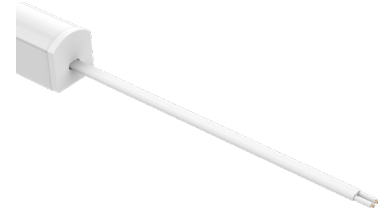

Dry Power Connector with White Jacket
(A1-ZAKY-SFR-PC-DRY-WH-X)
X = Specify Length, 36" Default, 25' Maximum

Part #	Length	Qty.
A1-ZAKY-SFR-PC-DRY-WH-	36"	
A1-ZAKY-SFR-PC-DRY-WH-		

Note: Specify 1 Power Connector for each lead required. Power Connectors are factory assembled to each length.



Dry Continuous Connector
(A1-ZAKY-SFR-CC-DRY-X)
X = Specify Length, 3" Default

Part #	Length	Qty.
A1-ZAKY-SFR-CC-DRY-	3"	
A1-ZAKY-SFR-CC-DRY-		

Note: Specify Continuous Connectors to traverse a gap or obstacle. Continuous Connectors are factory assembled to specified lengths.



Dry Continuous Connector with Black Jacket
(A1-ZAKY-SFR-CC-DRY-BK-X)
X = Specify Length, 3" Default

Part #	Length	Qty.
A1-ZAKY-SFR-CC-DRY-BK-	3"	
A1-ZAKY-SFR-CC-DRY-BK-		

Note: Specify Continuous Connectors to traverse a gap or obstacle. Continuous Connectors are factory assembled to specified lengths.



Dry Continuous Connector with White Jacket
(A1-ZAKY-SFR-CC-DRY-WH-X)
X = Specify Length, 3" Default

Part #	Length	Qty.
A1-ZAKY-SFR-CC-DRY-WH-	3"	
A1-ZAKY-SFR-CC-DRY-WH-		

Note: Specify Continuous Connectors to traverse a gap or obstacle. Continuous Connectors are factory assembled to specified lengths.

WET CONNECTORS (Sold Separately)

Note: Connectors are factory assembled to each run length. Connectors are subject to change without notice.

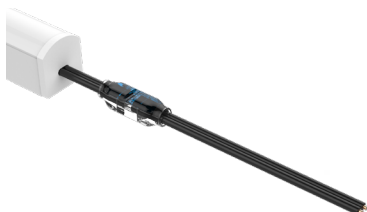

Wet Power Connector
(A1-ZAKY-SFR-PC-WET-X)
X = Specify Length, 36" Default, 25' Maximum

Part #	Length	Qty.
A1-ZAKY-SFR-PC-WET-	36"	
A1-ZAKY-SFR-PC-WET-		

Note: Specify 1 Power Connector for each lead required. Power Connectors are factory assembled to each length.



Wet Continuous Connector
(A1-ZAKY-SFR-CC-WET-X)
X = Specify Length, 3" Default

Part #	Length	Qty.
A1-ZAKY-SFR-CC-WET-	3"	
A1-ZAKY-SFR-CC-WET-		

Note: Specify Continuous Connectors to traverse a gap or obstacle. Continuous Connectors are factory assembled to specified lengths.

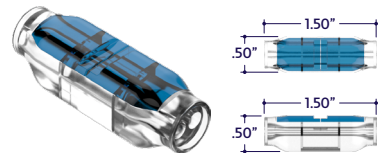

Part #	Qty.
A1-SC-2P-WET	

DESIGN GUIDELINES

Individual Fixture

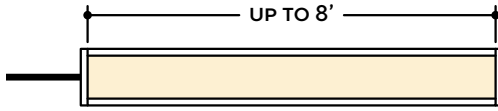

Continuous Run (Dry Location)

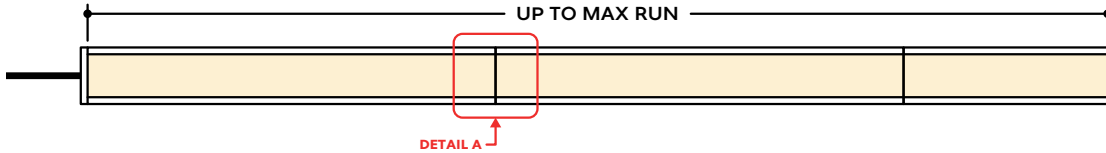

Continuous Run (Wet Location)

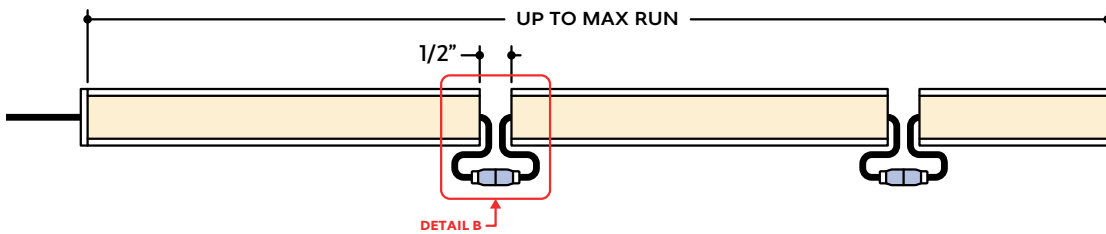

Runs with Continuous Connector (Dry Location)

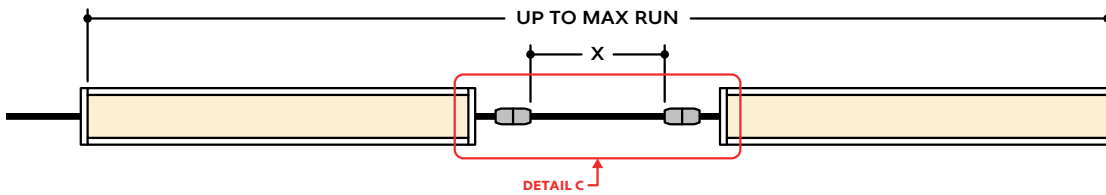

Runs with Continuous Connector (Wet Location)

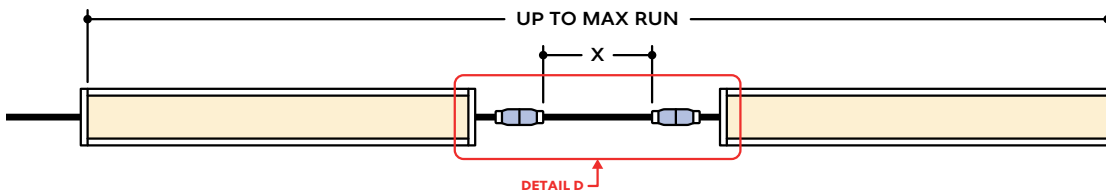

KEY

- Detail A** **Continuous Connection (Dry Location):** Luminaire segments connect using pins, leaving no gaps between segments, with a mounting clip holding the two segments together. Refer to installation instructions for additional information.
- Detail B** **Continuous Connection (Wet Location):** Luminaire segments are connected using a provided splice connector, with a 1/2" gap between segments.
- Detail C** **Dry Continuous Connector:** Used to span a corner or traverse a gap, corner, or obstacle in a dry location installation area.
- Detail D** **Wet Continuous Connector:** Used to span a corner or traverse a gap, corner, or obstacle in a wet location installation area.

Note: Drawings not to scale. Product may differ from examples shown.

CONNECTION SEQUENCE

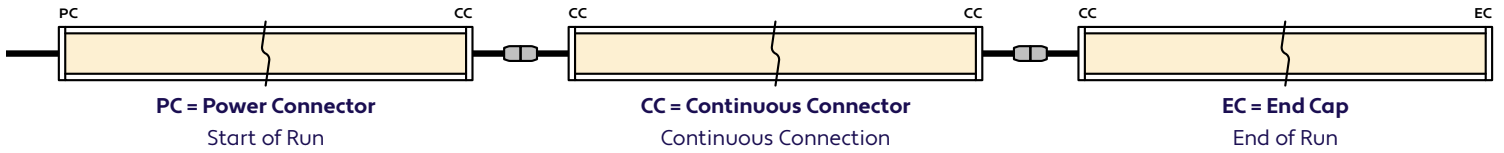

- Specifying a layout is not required to place an order.
- Configuration code applies to full length ordered and will be built per the Continuous Run models on Design Guidelines.
- Connector type subject to change based on availability and listing. Refer to Design Guidelines for details.

HOW TO SPECIFY CONFIGURATIONS

Example: 20' Straight Run

- 1x A1-ZAKY-SFR-CL-3.3W-10V-35K-DRY-NA-20'-PC-EC

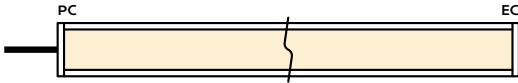

Example: 25' L-Shaped Run

- 1x A1-ZAKY-SFR-CL-3.3W-10V-35K-WET-NA-12'-PC-CC
- 1x A1-ZAKY-SFR-CL-3.3W-10V-35K-WET-NA-6'-CC-EC

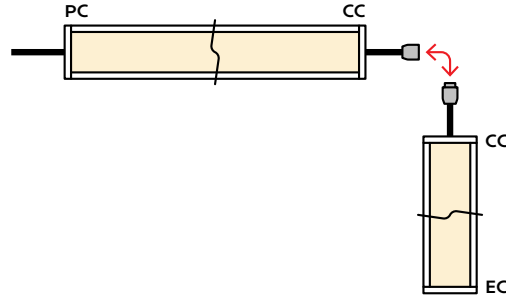

Example: 30' U-Shaped Run

- 1x A1-ZAKY-SFR-CL-3.3W-10V-35K-DRY-NA-6'-PC-CC
- 1x A1-ZAKY-SFR-CL-3.3W-10V-35K-DRY-NA-18'-CC-CC
- 1x A1-ZAKY-SFR-CL-3.3W-10V-35K-DRY-NA-6'-CC-EC

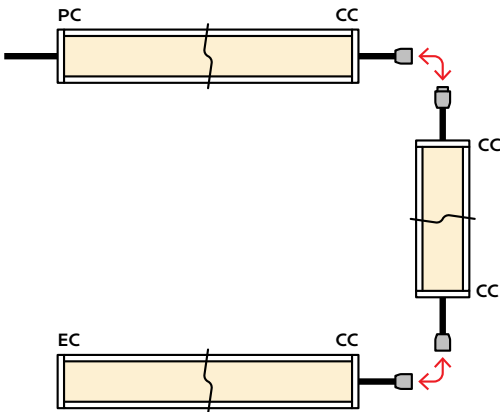

Example: 28' Rectangle Shaped Run

- 1x A1-ZAKY-SFR-CL-3.3W-10V-35K-WET-NA-11'-PC-CC
- 1x A1-ZAKY-SFR-CL-3.3W-10V-35K-WET-NA-3'-CC-CC
- 1x A1-ZAKY-SFR-CL-3.3W-10V-35K-WET-NA-11'-CC-CC
- 1x A1-ZAKY-SFR-CL-3.3W-10V-35K-WET-NA-3'-CC-EC

