

READ ENTIRE GUIDE BEFORE STARTING INSTALLATION

Important Notice: Verify correct luminaire was received with correct color temperature, voltage, and wattage before cutting or installing. ALUZ will not be responsible if incorrect luminaire is installed.

END VIEWS / DIMENSIONS

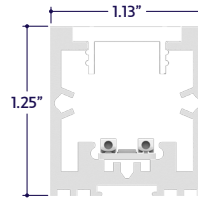

GENERAL FEATURES

Applications	Accent, Decorative, Surface, Recessed, Pendant Lighting
Lens	Clear, 50% Semi-Frosted, or 100% Frosted
Optics & Asymmetric	15°, 30°, 45°, 60°, 120°, and Asymmetric Optics
Length	Built to Order (+/- 1/8" Tolerance)
Construction	Aluminum Extrusion
Field Cutting	Dry Location Only
Weight	0.616 lbs per Foot
Mounting	Mounting Channel Mounting Clips (Sold Separately)
Listing	Dry, Wet, or IP67 Location UL2108, 67.1.9, 60.4, CSA C22.2 #9 UL8750, CSA250
Driver	Remote (Sold Separately)
Closet Rating	Up to 3.6 Watts per Foot Maximum
Temperature Ratings	Operating / Startup: -20° to 48°C (-4° to 120°F) Storage: -40° to 76°C (-40° to 170°F)
Installation Link	

ELECTRICAL

Dimming	0-10V, Forward / Reverse Phase, Lutron, DMX, DALI
Maximum Run (Class 1 Applications)	20' (6W), 30' (4W), 36' (3W, 2W)
Maximum Run (Class 2 Applications)	14' (6W), 21' (4W), 28' (3W), 36' (2W)
Luminaire Voltage	24VDC

PRODUCT INFORMATION

- For accent, decorative, surface, recessed, or pendant lighting.
- 24 volts DC for easy and safe installation.
- Long life, energy efficient LEDs.
- Can be ordered to specific lengths for when exact dimensions are known.
Example: 10 x 10'6"
- Plug and light system.
- Lead wires are typically 36" long and exit on one end.

ELECTRICAL REQUIREMENTS

- Low Voltage luminaires require a 24 Volt DC remote driver.
- Drivers are 120V - 277V AC (**UNV**) Input Voltage and 24V DC Output Voltage.
- To calculate driver size, determine Watts per Foot.
Example: 3W per Foot
- Determine Length in Feet.
Example: 15'
- Calculate Load: Multiply Watts per Foot x Length in Feet.
Example: 3W x 15' = 45W
- Choose a driver from catalog.
Example: 60 Watt Driver
- Determine maximum driver distance using Maximum Wire Length Table on drivers page.
Example: 45 watts is between 40W and 60W. Using #14 wire, maximum distance is 37' from driver to first LED

INSTALLATION RECOMMENDATIONS

- Luminaires must be mechanically attached directly to mounting surface using mounting clips, channels, or other appropriate means. Refer to installation step by step pages for details.
- Conduit raceway should be sleeved at one end for low voltage wires going to driver.

INSTALLATION TOOLS REQUIRED

- Electric Hammer Drill
- 14.4 to 28 Volt Cordless Drill
- Phillips Bits
- Utility Knife
- Electrical Cord
- Marker
- Wire Stripper
- Long Nose Pliers
- Drill Bits - Concrete or Wood
- Electrical Three Ways
- Safety Glasses
- Measuring Tape
- Laser Line or Chalk Line

WARNING

When using LED luminaires for any application, basic safety precautions should always be followed to reduce the risk of fire, electric shock, and personal injury. LED Lightstrip must be installed in accordance with the NEC or CEC as applicable. ALUZ will not be responsible for any damage or malfunction caused by the following:

- Ensure power is off before installation, during replacements, additions, or repairs.
- Do not use luminaires if damaged, such as broken boards, loose connections, or frayed wire insulation. Inspect before installing.
- Do not install luminaire in hazardous locations.
- Do not cover luminaire with any material, as it may cause LEDs to overheat, melt, or ignite. (Fig. 1)
- Do not paint on or over luminaire lens or LEDs. Paint or any other substance on lens or LEDs will cause a shift in color temperature.
- Soffit must be evenly painted with a neutral white to avoid color shift.
- Do not modify luminaire in the field.
- Do not overlap luminaires in any way.
- Only use luminaire with specified rated voltages. Do not exceed the specified voltage for any luminaire.
- Do not use luminaire extrusion as a raceway for additional wire. Non-factory feed through wires inside luminaire will void warranty.
- Ground Fault Circuit Interrupter (GFCI) protections should be provided on circuits or outlets when luminaire is used for outdoor applications.
- Surge protector must be set up for electrical power system to avoid damaging luminaire lighting system.
- Do not make wiring connections without referring to wiring diagrams.
- Do not cut wire while energized.
- Do not exceed maximum run lengths.
- Always follow sequence labeling for continuous runs. Continuous run segments are labeled in alphabetical order.
- Polarity of continuous run segments must be aligned.
- Do not assemble continuous runs prior to installing into mounting clips. Each segment must be installed one by one into mounting clips. The weight of the assembled segments will put strain on junctions, causing the board, pin, or terminals to break.
- Do not install continuous runs without a mounting clip at each junction between two segments.
- Do not mount with luminaires with staples, nails, or like means that might damage the insulation. Mount with double-sided tape and mounting clips.
- Do not install mounting clips over LED diodes or resistors.
- Do not penetrate luminaire board with any foreign object. (Fig. 2)
- Do not mount luminaire inside tanks or enclosures of any kind.
- Do not use improper screw head type on mounting clips. It will cause the mounting clip to open up and become dysfunctional.
- Do not modify mounting clips.
- Do not weld mounting clips to surface. Mounting clips must be mechanically attached with screws appropriate for mounting surface and weight of luminaire.
- Do not mount luminaires with less than the minimum number of mounting clips required. See mounting clips section for details.
- Do not install mounting clips on uneven surfaces. Use shims to level out height of mounting clips if necessary.
- Do not install mounting clips after luminaires have been assembled. Install mounting clips first, then install luminaire into mounting clips.
- Do not force luminaire into a space that is too small.
- Do not force luminaire with cord grip into soffit.
- Do not install luminaire at an angle within a cove. Only install luminaires straight within a cove.
- Do not bend extrusion around radius.
- Do not submerge dry or wet location luminaire in any liquid.
- Do not install wet location in outdoor coves without proper drainage. (Fig. 3)
- Do not install luminaire in any area that is continuously exposed to flowing or pooling water, such as underneath drain pipes, sprinklers, fountains, misters, etc.
- Do not install connectors without shrink tube for wet location. (Fig. 4)
- Do not use a lighter or open flame to heat shrink tube. (Fig. 5)
- Do not cut, puncture, or penetrate aluminum housing, end caps, or lens covers.
- Do not drop, bang, or rest weight upon luminaire.
- Do not apply excessive pressure to any part of luminaire board or LEDs. (Fig. 6)
- Do not bend luminaire power cord or continuous connector past permitted bend radius. Bending past permitted bend radius will break the seal of the cordgrip or damage the insulation. 1.5" minimum bend radius.
- Do not bend board in any direction. (Fig. 7)

FIGURES

Fig. 1

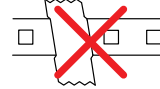

Fig. 2

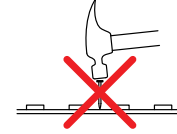

Fig. 3

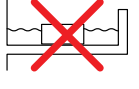

Fig. 4



Fig. 5

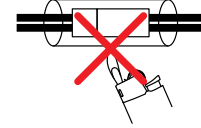

Fig. 6



Fig. 7

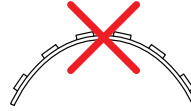

Fig. 8

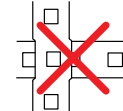
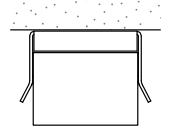

Fig. 9



CLEANING MATERIALS

The use of solvents and/or cleaners which are not compatible with polycarbonate will result in the softening, crazing, and/or cracking of the plastic part. This is especially true of polycarbonate lamps and mounting bases which may be under stress in their normal applications.

COMPATIBLE WITH POLYCARBONATE

- Mild soap and water
- Mineral Spirits
- Isobutyl Alcohol
- VM and P Naphtha
- Varsol No.2
- Mexane
- Freone TF and TE-35
- Ethanol
- Dirtex
- 2% Sol. Reg. Joy
- 10% Sol Bon Ami
- White Kerosene
- Methyl Alcohol
- Heptane
- Petroleum Ether / 65°C
- Isopropyl Alcohol
- Lacryl PCL-2035
- Polycarbonate Cleaner

NOT COMPATIBLE WITH POLYCARBONATE

- Trichlor
- Gasoline
- Liquid Detergents
- Acetone
- Carbon Tetrachloride
- Pink Lux (Phosphate free)
- Triclene
- Chlorinated Hydrocarbons
- #1 & #3 Denatured Alcohol
- Methyl Ethyl Keytone (MEK)
- Texize-8006, 8129, 8758
- MIBK
- Liquid Cleaner - 8211
- Toluol
- Agitene
- Benzol
- Ajax
- Kleenol Plastics
- Lysol
- Stanisol Naphtha
- Oils
- Lemon Joy (phosphate free)
- Diversol
- Lestoil

FORWARD / REVERSE PHASE DIMMING (PH)

Technical Requirements For Control Equipment

- Magnetic Low Voltage (MLV): Magnetic (core and coil, toroidal) transformer-supplied low voltage lighting.
- Electrical Characteristic: Inductive
- Special Requirements: Symmetric cycles ($VDC \leq 2$), smooth turn off (positive and negative periods are equal for safe MLV transformer operation).

PHASE DIMMER RATINGS

The stated VA (volt-ampere) rating is the rated capacity of the dimmer which includes the magnetic transformer heat losses and the lamp load. A transformer dissipates less than 20% of the connected load as heat. The lamp load plus the transformer loss determine the dimmer capacity required. See the example below.

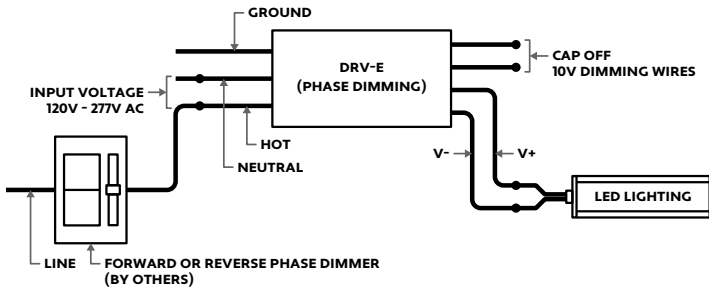

PHASE DIMMING WIRING DIAGRAM

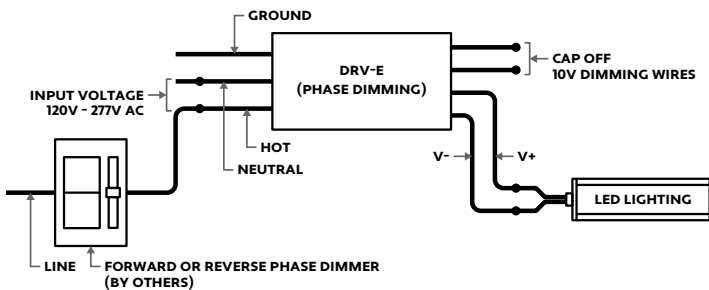

Notes: Wire colors vary based on model. See individual submittal for more information, or refer to wiring diagram on driver label. Confirm wire colors before connecting to power source. Cap off dimming wires individually for non-dimming applications. For best dimming performance, use a minimum load of 50% and a maximum load of 80%.

0-10V DIMMING (10V)

Technical Requirements For Control Equipment

- The light output of the LEDs operated by the controllable LED driver is controlled by DC voltage applied to the control input leads (gray and violet). The actual response curve of LED driver current versus control voltage.
- The control device must be capable of accepting or sinking the DC current flow from the driver. The DC current from the driver that must be sunk by the control circuit is approximately 150uA (+/-50% for isolated dim interfaces, up to 1.5mA for non isolated dim interfaces).
- If the control bus is opened, or if the control device internally opens the control bus under some conditions, the voltage on the control bus will then be a function of the drivers, which is 10-15V. Maximum light output will be delivered under this condition.
- If the control bus is shorted either by a mechanical switch in the control or by the circuitry of the control device, or inadvertently in the wiring, the current on the control bus will be less than 1.5mA.
- As can be determined from the two items, simple two-level operation of the drivers can be achieved by proper usage and application of a simple open/closed switch on the control bus with maximum light being achieved when the switch is open and minimum light with the switch is closed.
- The driver is intended to be used with control voltages between 0-10VDC volts peak maximum on the driver control leads.
- Control equipment intended to control more than one driver must be capable of sinking the current supplied to the control bus by the maximum number of drivers specified for the control device. At any given level setting it must maintain control bus voltage constant within a range of +/-5% as the number of drivers connected to the control bus varies from a minimum of one driver up to the maximum number specified for the control device.
- Driver of various ratings may be mixed on the same control system.

0-10V DIMMER RATINGS

The stated VA (volt-ampere) rating is the rated capacity of the dimmer which includes the electronic transformer heat losses and the lamp load. A transformer dissipates less than 20% of the connected load as heat. The lamp load plus the transformer loss determine the dimmer capacity required. See the example below.

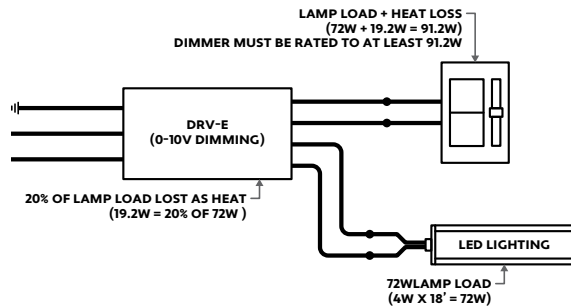

0-10V DIMMING WIRING DIAGRAM

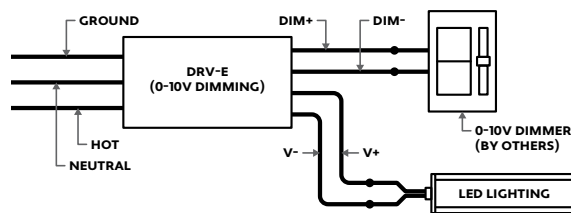

MAXIMUM RUN BASED ON 80% LOAD OF ELECTRONIC DRIVER MAXIMUM WATTAGE

Driver Wattage	80% Load	1.5W Max Run	2W Max Run	2.5W Max Run	3W Max Run	3.6W Max Run	4W Max Run	4.5W Max Run	5W Max Run	5.5W Max Run	6W Max Run	6.5W Max Run
30	24W	16'	12'	9.6'	8'	6.6'	6'	5.3'	4.8'	4.36'	4'	3.69'
60	48W	32'	24'	19.2'	16'	13.3'	12'	10.6'	9.6'	8.7'	8'	7.3'
96	76.8W	51.2'	38.4'	30.7'	25.6'	21.3'	19.2'	17.1'	15.36'	13.9'	12.8'	11.8'
150	120W	80'	60'	48'	40'	33.3'	30'	26.6'	24'	21.8'	20'	18.4'
200	160W	106.6'	80'	64'	53.3'	44.4'	40'	35.5'	32'	29'	26.6'	24.6'
300	240W	160'	120'	96'	80'	66.6'	60'	53.3'	48'	43.6'	40'	36.9'

Note: Maximum Run refers to the total length of lighting that can be connected to a single driver. Maximum Runs for individual products still apply.

MAXIMUM WIRE LENGTH TO PREVENT EXCESS VOLTAGE DROP

Wire Size	Load Wattage (W)												
	15	24	30	48	60	76	96	120	150	160	200	240	300
20 AWG	79'	49'	39'	25'	20'	16'	12'	10'	8'	7'	6'	5'	4'
18 AWG	125'	78'	63'	39'	31'	25'	20'	16'	13'	12'	9'	8'	6'
16 AWG	199'	125'	100'	62'	50'	39'	31'	25'	20'	19'	15'	12'	10'
14 AWG	317'	198'	158'	99'	79'	63'	50'	40'	32'	30'	24'	20'	16'
12 AWG	504'	315'	252'	157'	126'	100'	79'	63'	50'	47'	38'	31'	25'
10 AWG	801'	501'	400'	250'	200'	158'	125'	100'	80'	75'	60'	50'	40'
8 AWG	1273'	796'	637'	398'	318'	252'	199'	159'	127'	120'	96'	80'	64'

MAXIMUM WIRING DISTANCE OF DRIVER TO LIGHTING

The maximum wiring distance of driver to LED Lighting refers to the wire used between the driver and first LED of the luminaire. If the wire gauge is inadequate for the wiring distance, the luminaire will receive decreased voltage, insufficient to power the LEDs. Refer to the table to determine appropriate wiring distances based on wire gauge and the LED load.



MOUNTING INSIDE AN ENCLOSURE

- Only mount drivers inside enclosures rated for your application
- Always ground drivers to enclosure
- Do not mount drivers without an enclosure
- Use enclosure knockouts and water-tight conduit fittings when applicable

DRIVER CARE

- Do not submerge drivers in any liquid
- Do not leave any exposed wires
- Do not cover driver without proper ventilation
- Do not install damaged driver
- Do not exceed maximum load

DIMMER TRIM VALUES

Set dimmer trim value as needed to prevent flickering and irregular dimming. Review dimmer specifications for trim value adjustment. Dimmers by others.

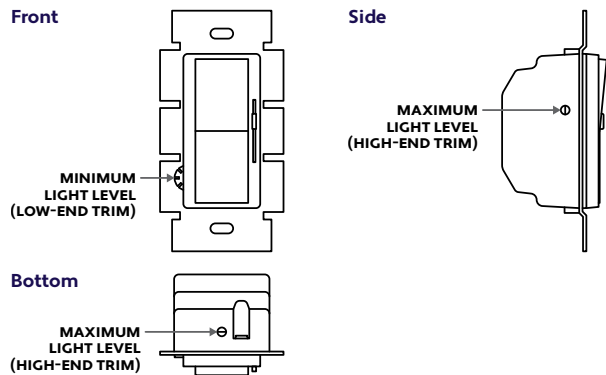

LUTRON HI-LUME 2-WIRE DIMMING (LTEA)

Technical Requirements For Control Equipment

- The Hi-lume 1% 2-Wire LED Driver (LTEA) is a high performance LED driver that provides a smooth, continuous, flicker-free 1% dimming for virtually any LED fixture. Primary voltage is 120V and secondary side is 12VDC or 24VDC. A rated life time of 50,000 hours @tc -149°F (65°C). Inrush current: < 2A. Minimum operating temperature ta = 32°F (0°C).
- Continuous, flicker-free dimming from 100% to 1%. Compatible with selected Maestro Wireless, RadioRA 2, HomeWorks QS, GRAFIK Eye QS, GRAFIK Systems, Quantum, and C-L Dimmers.
- The driver is California Title 24 JA8 Compliant.

Wiring Diagram for Controls Requiring Neutral (JA8 Compliant)

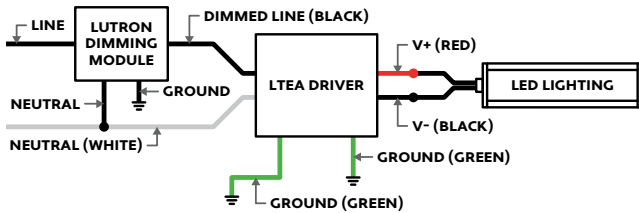

Wiring Diagram for Controls Not Requiring Neutral (JA8 Compliant)

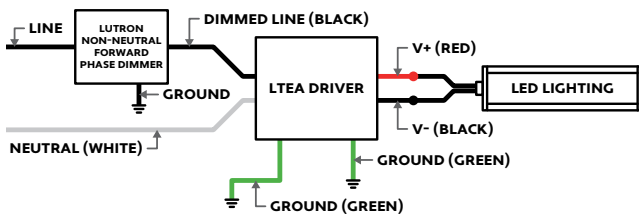

LUTRON HI-LUME 3-WIRE DIMMING (L3DA)

Technical Requirements For Control Equipment

- Hi-lume 1% EcoSystem/3-Wire Driver (L3DA) is a high-performance LED driver that provides smooth, continuous 1% dimming for virtually any LED fixture, primary voltage is 120-277 V~ at 50/60 Hz and secondary side is 12VDC or 24VDC. A rated life time of 50,000 hours @tc -149°F (65°C). Inrush current: < 2A. Minimum operating temperature ta = 32°F (0°C).
- Continuous, flicker-free dimming from 100% to 1%. Compatible with Energi Savr Node unit with EcoSystem, GRAFIK Eye QS control unit, PowPak dimming module with EcoSystem, and Quantum systems, allowing for integration into a planned or existing EcoSystem lighting control solution. Standard 3-wire, line-voltage phase control technology for consistent dimming performance.

Wiring Diagram for 3-Wire Controls

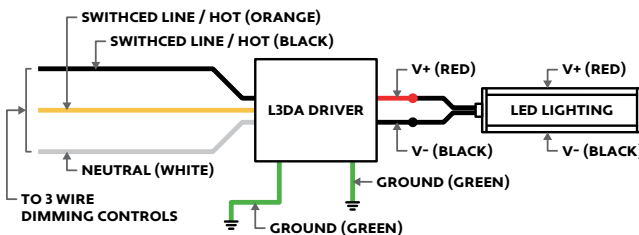

Wiring Diagram for EcoSystem Digital Controls

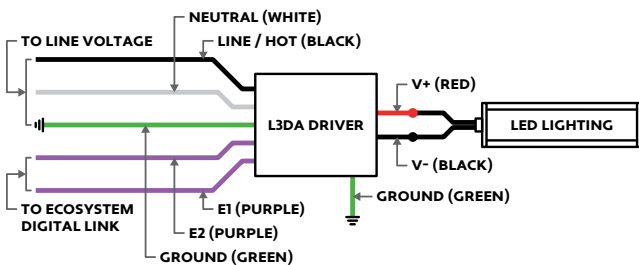

Note: Colors shown on wiring diagrams correspond to terminals on driver

LUTRON HI-LUME 3-WIRE PREMIER DIMMING (L3D0)

Technical Requirements For Control Equipment

- Hi-lume Premier 0.1% EcoSystem / 3 Wire constant voltage 24V LED driver with Soft-on, Fade-to-Black. The Hi-lume Premier 0.1% Constant Voltage Driver is a high-performance LED driver capable of controlling up to 96W of 24V constant voltage loads. This driver provides smooth and continuous dimming down to 0.1% low-end. It is ideal for use with strip lighting in applications such as coves, under or over cabinet lighting and pathway lighting. The driver is UL Listed with an integrated wiring compartment and can be mounted up to 150' away from the load.
- Continuous, flicker-free dimming from 100% to 0.1%
- Soft-on, Fade-to-Black operation for EcoSystem controls: fades smoothly between 0% and 0.1% when turned on and off for an incandescent like dimming experience.
- PWM dimming meets IEEE1789 over the entire dimming range.
- UL Listed for United States and Canada (cULus®).
- NOM certified for Mexico.
- Field Adjustment Knob offers customer low-end light output tuning for better fixture-to-fixture matching.
- Guaranteed dimming performance when used with Lutron controls:
 - HomeWorks QS, Energi Savr Node units with EcoSystem controls, GRAFIK Eye QS with EcoSystem controls, PowPak with EcoSystem dimming modules, PowPak with EcoSystem wireless fixture controls, and Quantum systems, allowing for integration into a planned or existing EcoSystem lighting control solution.
 - Lutron 3-wire controls and interfaces.
- Protected from miswires of input power, up to 277 V~, to EcoSystem control inputs.
- Rated lifetime of 50,000 hours at 40 °C (104 °F) ambient temperature and max load.
- FCC Part 15
 - Class A (277 V~)
 - Class B (120 V~)
- The driver is California Title 24 JA8 Compliant.

Wiring Diagram for 3-Wire Controls (JA8 Compliant)

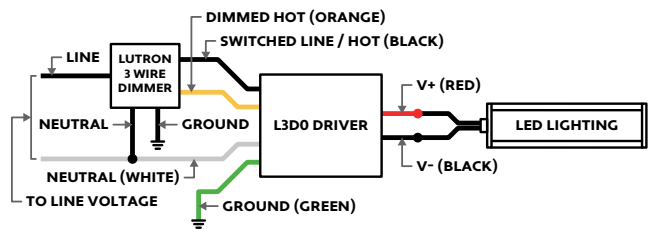

Wiring Diagram for EcoSystem Digital Controls (JA8 Compliant)

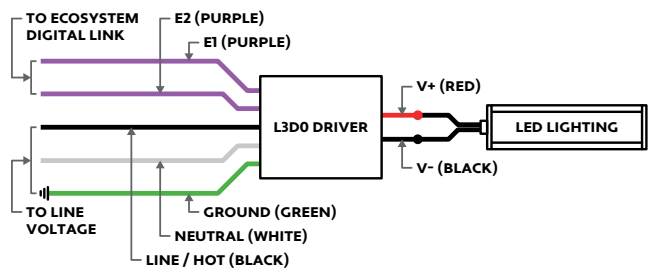
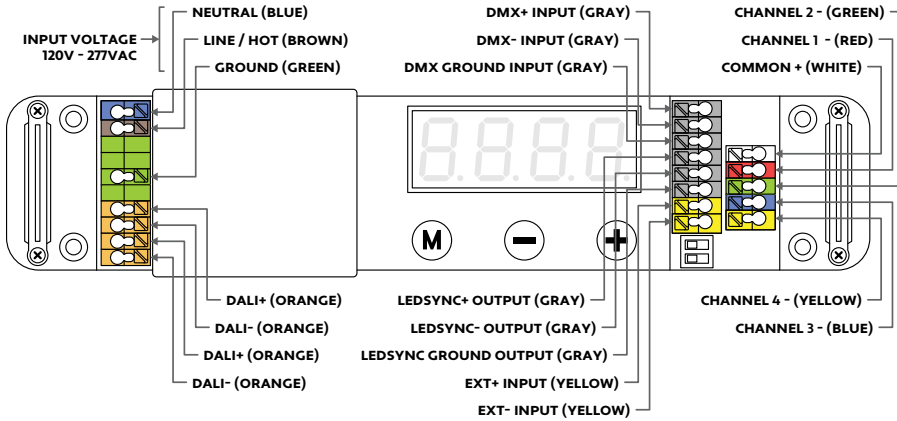
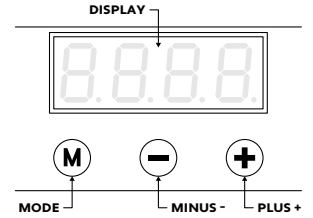

DIAGRAM OF DRIVER



DIGITAL INTERFACE



NOTES (DMX)

- Wire colors on diagram correspond to colors of driver terminals.
- Default DMX address of each luminaire is 001. Consult a third party DMX commissioner to modify at time of installation. ALUZ does not provide DMX commissioning.
- DMX Address must be set for each driver. Default DMX address is 001.
- A DMX Control System (by others) must be used to operate the lighting.
- The last driver in a daisy chain sequence must be terminated.
- Driver load not to exceed 100W.
- For best dimming performance, it is recommended to load drivers to a minimum of 50% (50W) and a maximum of 80% (80W).
- Up to 28 drivers may be daisy chained together using shielded cable specified for DMX wiring.
- Ensure DIP Switch 1 is set to ON (Left) to activate 24V operation.

DMX Wiring: Static White

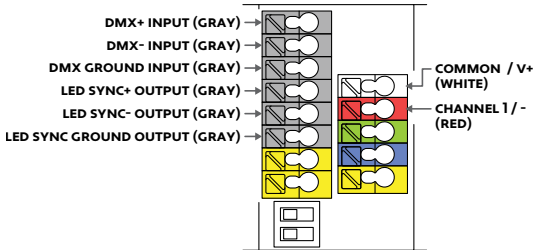

DMX Wiring: RGBW

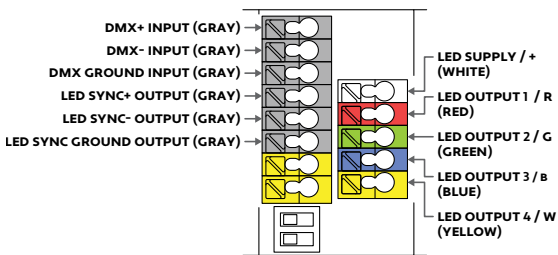

DMX Wiring: Dynamic White (DWH)

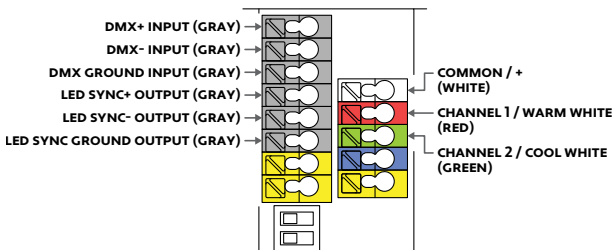

DMX Daisy Chain

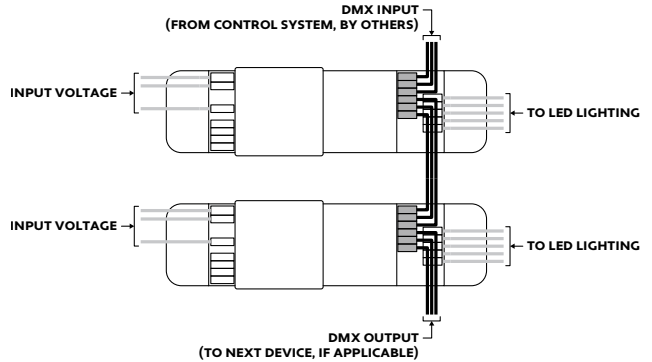

NOTES (DALI)

- Wire colors on diagram correspond to colors of driver terminals.
- DALI commissioning to be performed by a third party at time of installation. ALUZ does not provide DALI commissioning.
- DALI Address must be set for each driver.
- A DALI Control System (by others) must be used to operate the lighting.
- Driver load not to exceed 100W.
- For best dimming performance, it is recommended to load drivers to a minimum of 50% (50W) and a maximum of 80% (80W).
- Up to 28 drivers may be daisy chained together using shielded cable specified for DALI wiring.
- Ensure DIP Switch 1 is set to ON (Left) to activate 24V operation.

DALI Daisy Chain

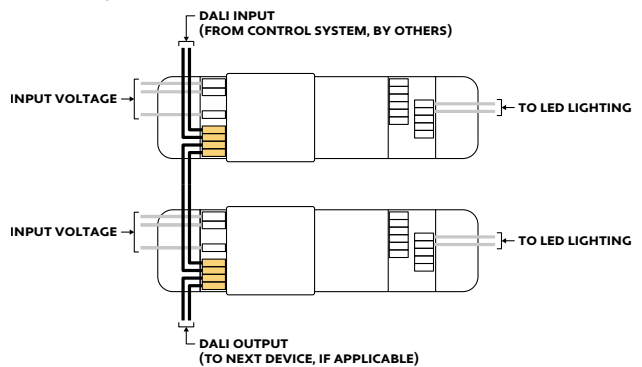

MODE OF OPERATION

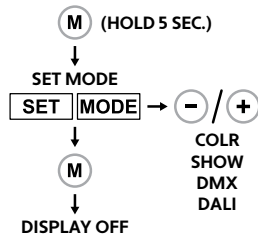

- Set Mode to DMX or DALI

SET LED GROUPS

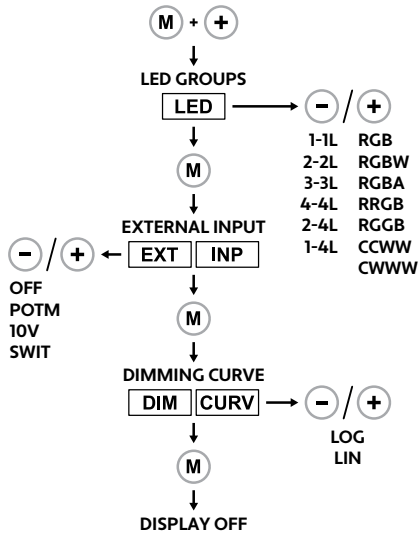

- Set LED Groups to RGBW for RGBW lighting.
- Set LED Groups to CCWW for Dynamic White lighting.
- Set External Input to OFF.
- Set Dimming Curve to Linear.

STANDALONE OPERATION (Network Operation)

Set DMX Address

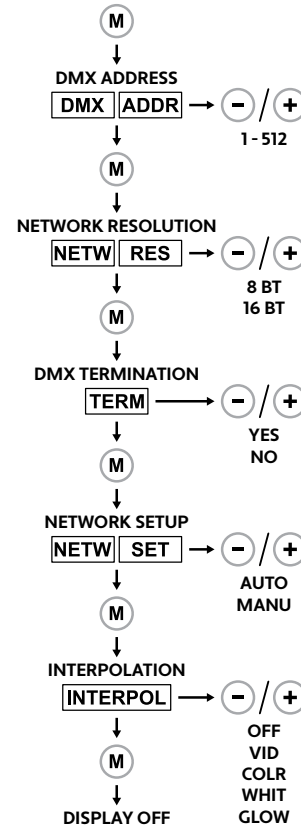

Set DALI Address

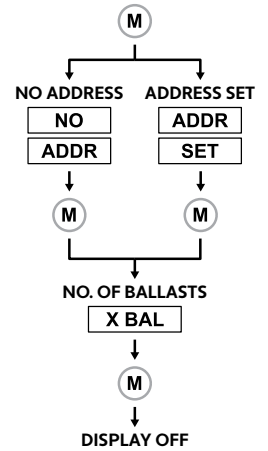

- Consult with a third-party DMX or DALI professional to determine which settings are best for your application. ALUZ does not provide DMX or DALI commissioning.

OTHER FUNCTIONS

Visual Test



Reset Settings

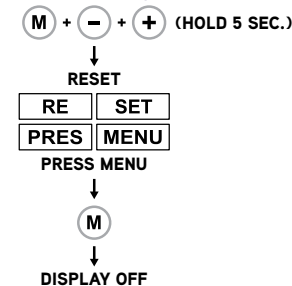

Lock Driver

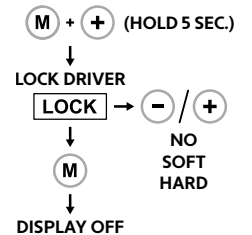

- Always perform the visual test function after wiring to ensure all channels are behaving appropriately.
- Reset driver to factory settings if necessary. It is recommended to reset each driver before adjusting settings for the first time.
- Lock driver if applicable (not recommended).

STANDALONE OPERATION (Color / Show)

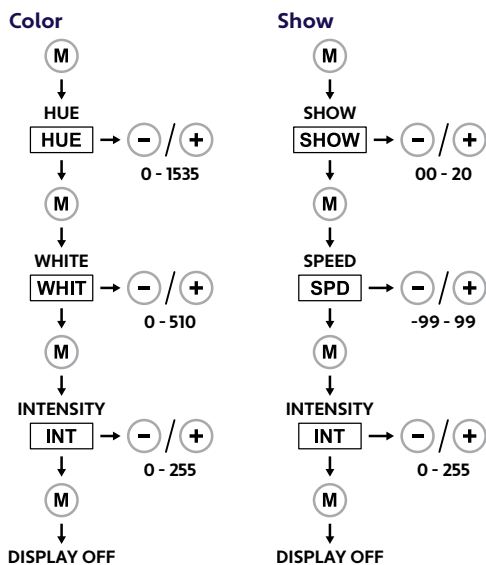

- Standalone Operation should only be used when a control system is not present to control the lighting (not recommended).

- 1 Determine where fixture needs to be trimmed. Mark extrusion and lens with a non-permanent marker.

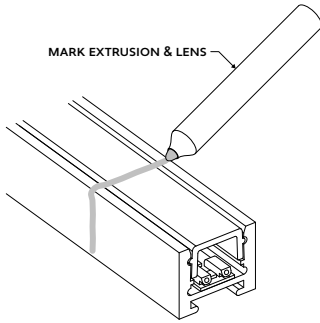

- 2 Remove lens to access PCBs.

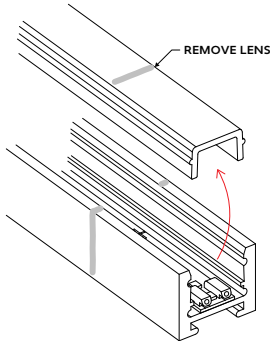

- 3 Carefully lift the last PCB in the fixture that overlaps the cut mark, ensuring terminals & pins are not damaged in the process.

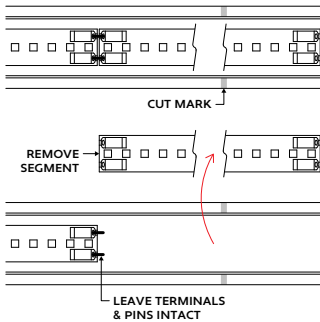

- 4 Mask the remaining PCBs and LEDs with masking tape to protect during cutting, then replace lens.

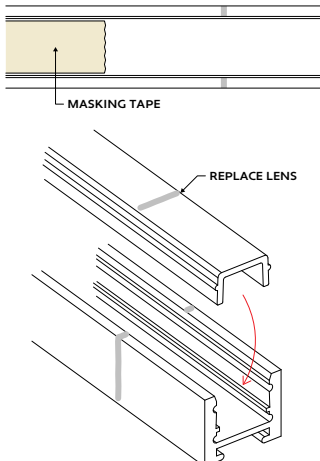

- 5 Cut fixture to size. Only use a miter saw with a blade suitable to cut aluminum & plastic. The final cut must be clean and free of jagged edges.

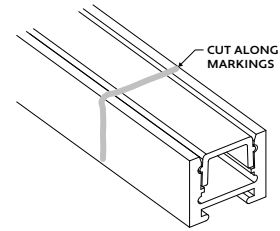

- 6 After cutting, wipe away excess markings, then remove lens and clear fixture of all metal & plastic debris.

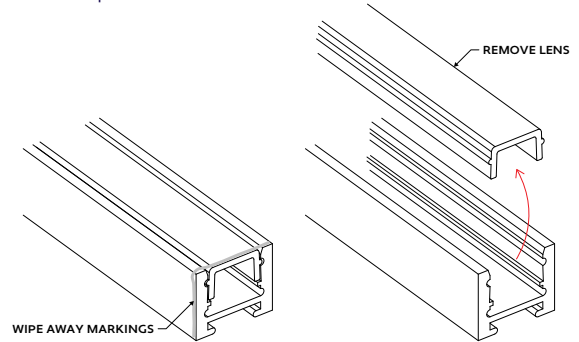

- 7 Remove masking tape from PCBs and LEDs, then perform a continuity test after clearing debris from inside of fixture.

- 8 Lay removed segment inside extrusion to measure where modules will be cut. Cut modules at markings. The PCB is cuttable every 1". Use sharp, tapered cutters to ensure a clean cut.
Recommendation: American Hakko Products CHP-170 (by others).

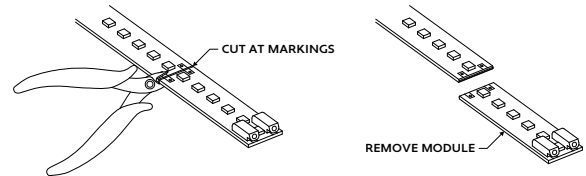

- 9 After PCB is trimmed, replace the segment, connecting terminals.

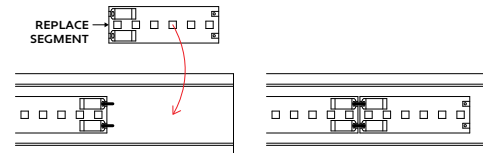

- 10 Replace lens and install fixture into place, then perform another continuity test before connecting to power source.

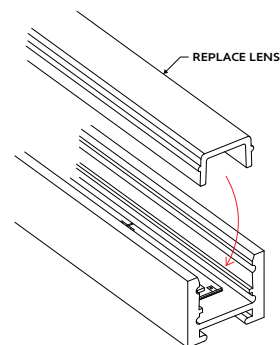

SOLDERING GUIDE

- 1 If applicable, prepare wires by stripping 1/8" from the end of each wire, then tin the tips of the wire with solder. Apply heat to stripped portion of wire, then add a small amount of solder until stripped portion of wire is fully covered in solder.
- 2 Solder lead wires to solder contacts on the end of board. Solder the positive wire (red) to the contact marked "+". Solder the neutral wire (white) to the contact marked "-".
Note: Solder iron not to exceed 720°F. Heat joint with tip of iron. Heat both the solder pad and the wire. Add a small drop of solder on the tip of solder iron to transfer the heat to joint quickly; it should melt and flow smoothly, covering the wire and pad. Remove iron once enough solder has been added to the components. Allow 5 seconds for the joint to cool.

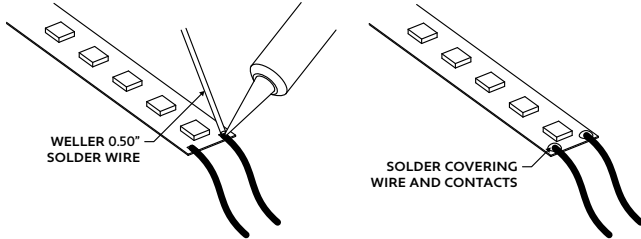

Note: Appearance of lightstrip may differ from example shown. Refer to wiring diagrams from installation instructions before soldering any wires.

- 3 After soldering, check underside of LED board to ensure excess solder is not present. If present, cover it with non-conductive electrical tape (by others).

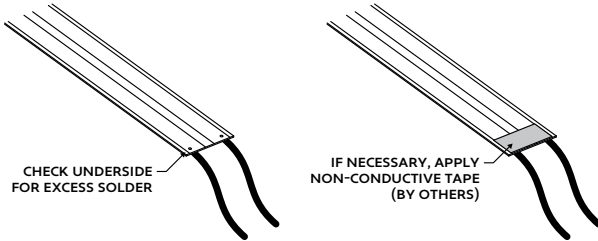

CONTINUOUS RUNS

- 1 Insert terminal connectors into each terminal where two LED boards will be joined. Push boards together leaving no gap.
Note: Ensure + and - terminals are aligned throughout the entire run.

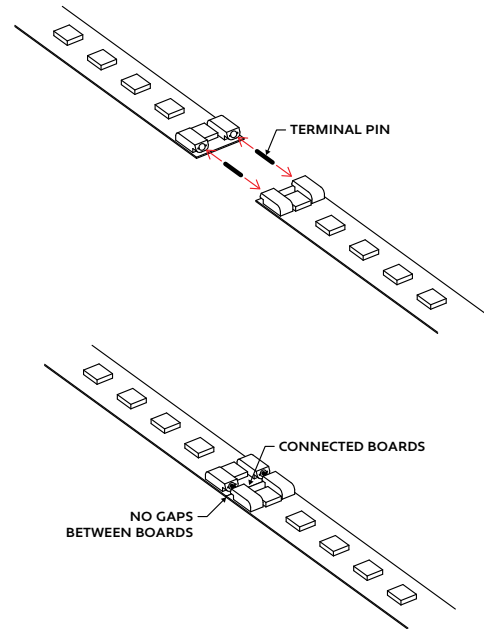

CONNECTORS

- 1 Insert power connector or continuous connector lead wires into LED board terminals. Insert the positive wire (red) into the terminal marked "+". Insert the neutral wire (white) into the terminal marked "-".
Note: Ensure + and - terminals are aligned throughout the entire run.

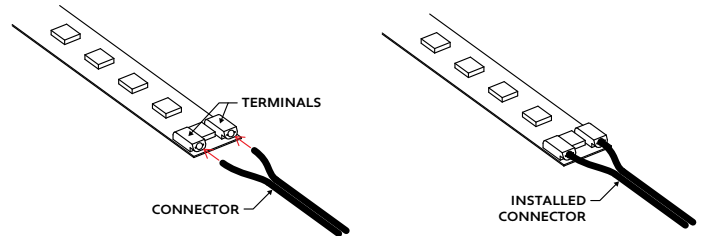

DRY LOCATION APPLICATIONS

- 1 Measure area where luminaire will be installed. Use a laser line to create a reference line along installation area, ensuring consistent alignment of mounting clips. Mark location where each mounting clip will be installed along reference line.
- 2 Use 1 mounting clip every 2', rounded up. Use a minimum of 2 mounting clips per fixture segment. For vertical applications, create a stopper at the bottom of the run to prevent sliding.
- 3 Use a mounting clip at the junction between two fixture segments.
Example: 20' Run.

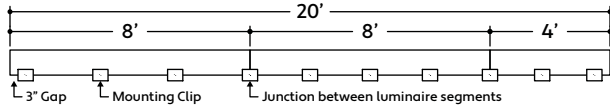

- 4 Lay mounting clips along reference line and pre-drill using an appropriate drill bit for surface material and screw size. Typical screw size is 8/32 x 1".
Note: Allow 1/4" clearance on each side of mounting clip due to lateral expansion. Only install mounting clips on flat, even surfaces.

- 5 Screw mounting clips to surface, then snap fixture into mounting clips.

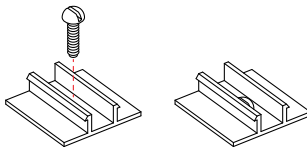

WET LOCATION APPLICATIONS

- 1 Measure area where luminaire will be installed. Use a laser line to create a reference line along installation area, ensuring consistent alignment of mounting clips. Mark location where each mounting clip will be installed along reference line.
- 2 Use 1 mounting clip every 2', rounded up. Use a minimum of 2 mounting clips per fixture segment. For vertical applications, create a stopper at the bottom of the run to prevent sliding.
- 3 Space mounting clips evenly throughout the run.
Example: 20' Run.

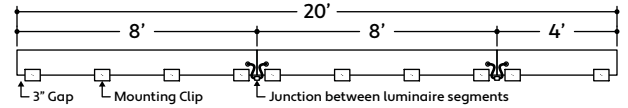

WET LOCATION APPLICATIONS

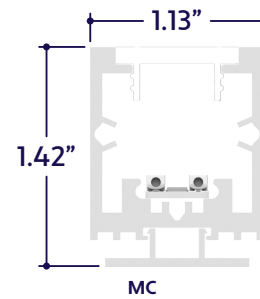

- 1 Measure area where luminaire will be installed. Use a laser line to create a reference line along installation area, ensuring consistent alignment of mounting clips. Mark location where each mounting clip will be installed along reference line.
- 2 Mark location where mounting clips will be installed.
Note: The number of required mounting clips differs for dry and wet location products. Verify number of mounting clips is appropriate for installation environment before installing. Do not install luminaires with inadequate number of mounting clips.
- 3 Lay mounting clips along reference line and pre-drill using an appropriate drill bit for surface and screw size.
Recommendation: 8/32 x 1" countersink screw.
Note: Allow 1/4" clearance for lateral expansion of assembled mounting clips. Only install mounting clips on flat, even surfaces.
- 4 Each luminaire segment has a male and female end used for continuous connections. Lay out each segment next to the mounting clips where they will be installed. Position the segments as follows: power lead end, female end, male end, and so on.

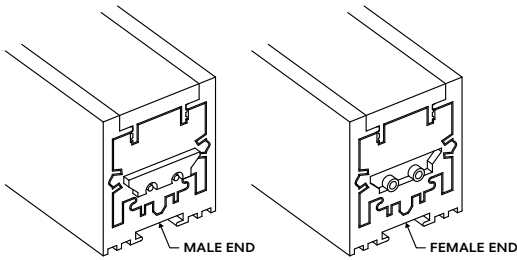

- 5 Ensure segments are aligned with mounting clips per the mounting diagrams. Make any necessary adjustments to mounting clip positions, then screw mounting clips to surface.
Note: Allow 1/4" clearance on each side of mounting clip to account for lateral expansion. Only install mounting clips on flat, even surfaces.

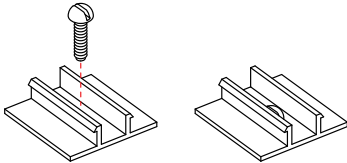

- 6 Snap luminaire segments into mounting clips. Position each segment end with a continuous connection end halfway across the mounting clip.

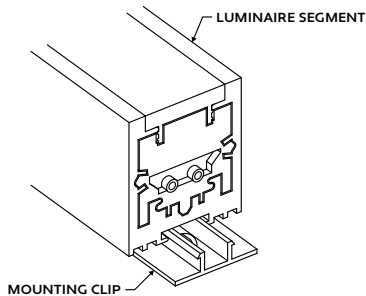

- 7 Snap the next segment into mounting clips, then slide towards the previously mounted segment. Ensure female and male pins are aligned before applying force. Push segments together until they fit snugly with no gaps.

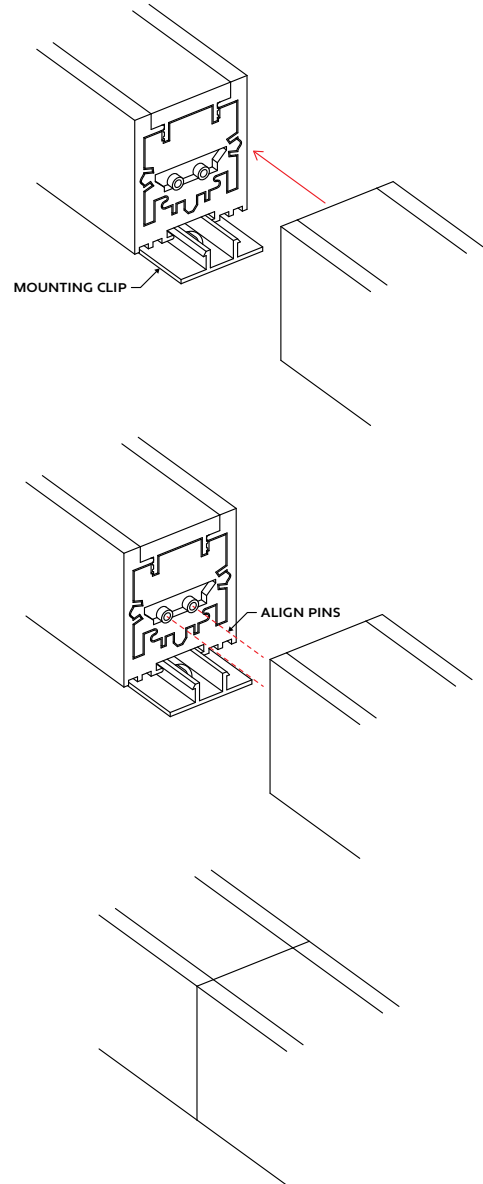

- 8 Continue mounting and connecting segments until entire run has been mounted.
- 9 Perform a continuity test before connecting to power source. Refer to **Continuity Test** for details.
- 10 If applicable, install End Caps at the end of each run. Feed the power lead through end cap exit and connect to power source.

- 1 Measure area where luminaire will be installed. Use a laser line to create a reference line along installation area, ensuring consistent alignment of mounting clips. Mark location where each mounting clip will be installed along reference line.
- 2 Mark location where mounting clips will be installed.
Note: The number of required mounting clips differs for dry and wet location products. Verify number of mounting clips is appropriate for installation environment before installing. Do not install luminaires with inadequate number of mounting clips.

- 3 Lay mounting clips along reference line and pre-drill using an appropriate drill bit for surface and screw size.
Recommendation: 8/32 x 1" countersink screw.
Note: Allow 1/4" clearance for lateral expansion of assembled mounting clips. Only install mounting clips on flat, even surfaces.

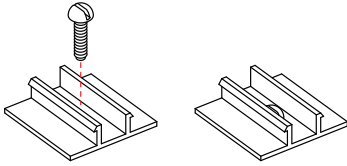

- 4 Screw mounting clips to surface, then snap fixtures into mounting clips.
Note: Ensure fixture segments are aligned.

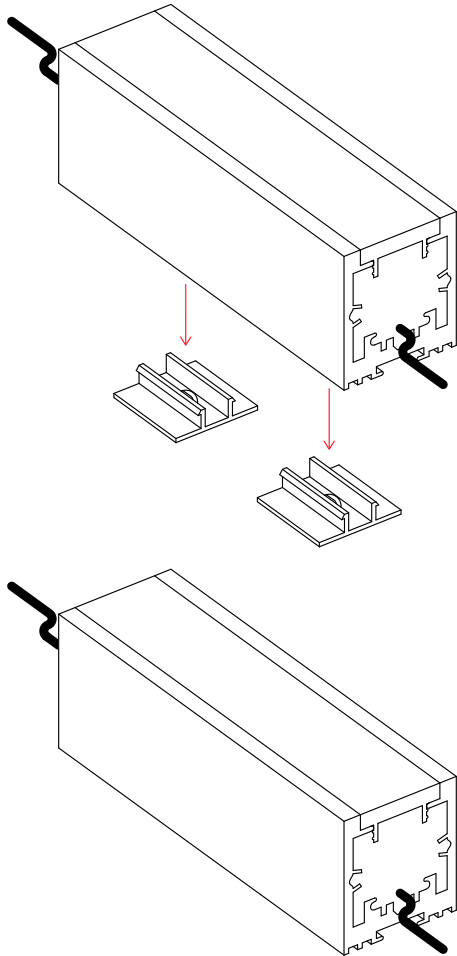

- 5 If applicable, make connections between fixture segments using wet location splice connectors.
Note: Follow the steps below or refer to **Wet Splice Connector** cut sheet for additional details.

- a Slide shrink tube over wires and connector. Part wires 3/4" for insertion into the wet splice connector.

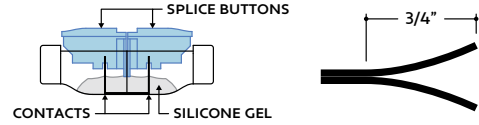

- b Push wires into connector until they stop at the center point. Repeat process for the other side.
Note: The positive wire (+) has a ribbed wire jacket, the negative wire (-) has a smooth wire jacket.

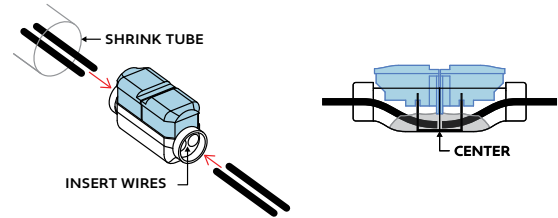

- c Use pliers to push splice buttons down completely until they sever the wire and snap into place.

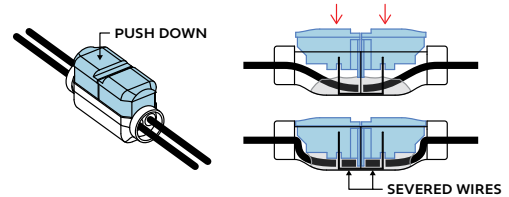

- d Slide shrink tube over connector and apply heat. The shrink tube will shrink down around the connector. Apply silicone around the ends to create a stronger seal.
Note: Do not use an open flame such as a lighter or torch to heat shrink tube.

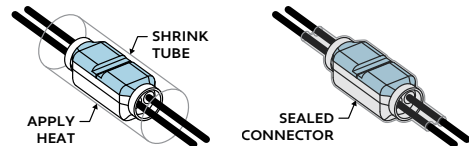

- e Position connection as needed. Maintain a gap of no more than 1/2" for continuous runs to retain even illumination.

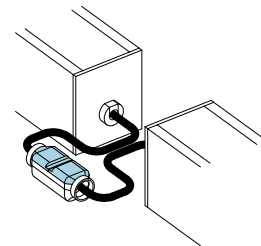

- 6 Perform a continuity test before connecting to power source. Refer to **Continuity Test** for details.

- 7 If applicable, install End Caps at the end of each run. Feed the power lead through end cap exit and connect to power source.

TROUBLESHOOTING TIPS

- Do not reset the breaker multiple times.
- If the unit is overloaded, the breaker will trip, shutting off the driver and lights.
- If the breaker reset button has been held down by hand or any type of pressure, such as duct tape, or if the breaker has been reset multiple times without troubleshooting, the unit will:
 - Burn the driver bobbin.
 - Burn the thermal or magnetic breaker.
 - Burn the driver lead wires due to high amperage caused by overload.
 - Short circuit in line which will not allow the breaker to reset.
 - Damage the lighting.

1 Turn off power before beginning. Verify power is off by using a not contact circuit tester (by others).

2 Check the board for damage, such as cuts, punctures, twisting, or crushing. If there is excessive damage to the board, it must be replaced.

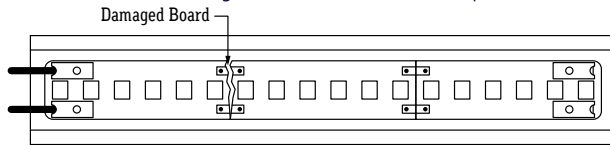

3 Check the run for any particles that may cause a short. Check the end cap, power connector, and board for any metal flakes or shavings. Clear the run of any shavings or particles if present, then perform a continuity test to confirm the short has been eliminated.

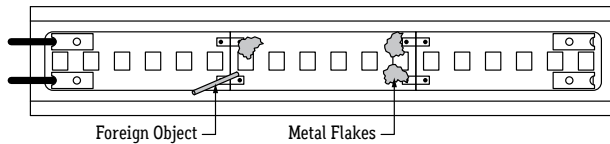

4 Check board cuts to ensure they are clean. Frayed, split, or sloppily cut boards can damage the circuit, resulting in flickering, dimness, or LED outages.

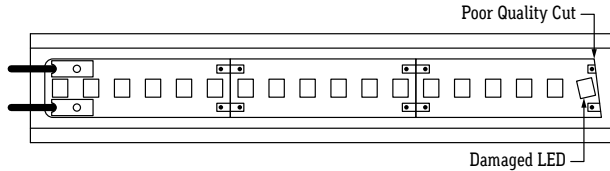

5 Check terminal connections between LED boards. If a terminal is loose, damaged, or absent, the board must be replaced. Check soldered connections to LED boards, if applicable.

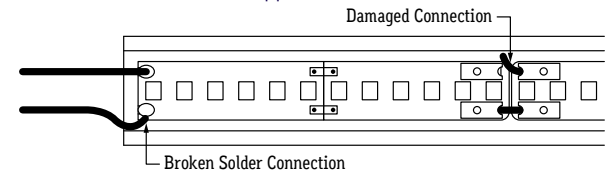

6 Check the run for any particles that may cause a short. Check the end cap, power connector, and board for any metal flakes or shavings. Clear the run of any shavings or particles if present, then perform a continuity test to confirm the short has been eliminated.

7 Check the run for any water inside end cap, power connector, or lightstrip. If water or condensation is present, the lightstrip must be replaced.

CONTINUITY TEST

A continuity test is performed to determine if electricity can pass through two points on an electrical circuit. This helps identify shorts or malfunctions in the line or luminaire. Use a multimeter or continuity tester to perform the steps below.

- Always perform a continuity test before connecting to power source.
- Malfunctions are not always as obvious as the lights not turning on.
- A short or malfunction in the line or luminaire will cause damage over time, irreparably damaging the lighting and voiding warranty.

EXAMPLE OF MULTIMETER (BY OTHERS)

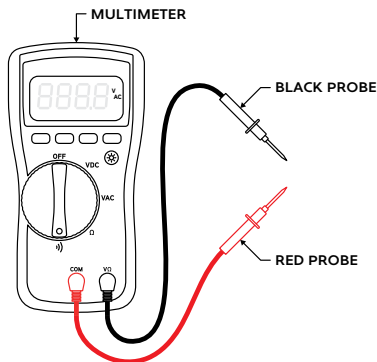

- 1 Turn off power before beginning. Verify power is off by using a non-contact circuit tester (by others). Touch the probe of the tester to the positive wire of the power source. The tester will light up if an electrical current is detected.
- 2 Setup your multimeter tester (by others). First, insert the black probe lead into the COM jack, then insert the red probe lead into the VΩ jack.

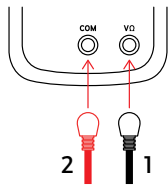

- 3 Verify multimeter is functional by touching probes together. The multimeter should beep, flash, or read 0Ω (ohms) of resistance.
- 4 Touch the red probe to the positive (+) wire and the black probe to the negative (-) wire of the luminaire. If a conductive path is formed between the positive and negative wires, the multimeter will beep, flash, or read 0Ω (ohms) of resistance. Troubleshoot to identify the malfunction in the line. If there is no conductive path formed, the multimeter will not show any feedback.

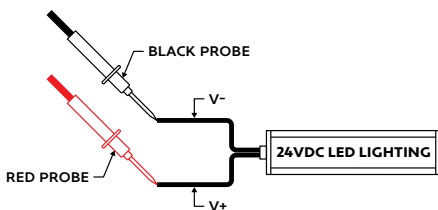

- 5 Touch the red probe to the luminaire extrusion and the black probe to the positive (+) wire. If a conductive path is formed between the extrusion and the positive wire, the multimeter will beep, flash, or read 0Ω (ohms). Troubleshoot to identify the malfunction in the line. If there is no conductive path, the multimeter will not show any feedback.

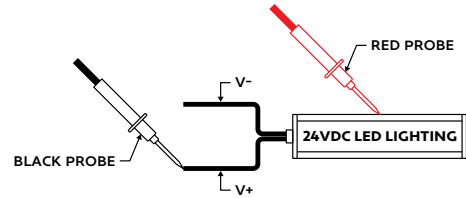

- 6 Touch the red probe to the luminaire extrusion and the black probe to the negative (-) wire. If a conductive path is formed between the extrusion and the negative wire, the multimeter will beep, flash, or read 0Ω (ohms). Troubleshoot to identify the malfunction in the line. If there is no conductive path, the multimeter will not show any feedback.

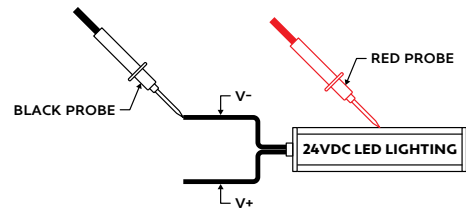

- 7 Set multimeter to DC voltage and test power source. Confirm the correct voltage before connecting luminaire to power source. If the voltage reading is more than 1 volt greater than the marked output voltage, there is a problem with the power source or driver.
- 8 Connect luminaire to power source via power connector. If LEDs do not turn on, flip the polarity (+/-) or power source connection to power connector.