

READ ENTIRE GUIDE BEFORE STARTING INSTALLATION

Important Notice: Verify correct luminaire was received with correct color temperature, voltage, and wattage before cutting or installing. ALUZ will not be responsible if incorrect luminaire is installed.

END VIEW / DIMENSIONS

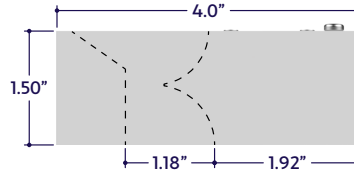

GENERAL FEATURES

Applications	Accent, Cove, Perimeter Lighting
Lens	Clear, 50% Semi-Frosted, or 100% Frosted
Viewing Angle	120°
Length	Built to Order (+/- 1.8" Tolerance)
Construction	Aluminum Extrusion
Weight	0.38 lbs per foot
Mounting	Mounting Brackets (Sold Separately)
Listing	Dry or Damp Location UL1598, CSA C22.2#250.0 UL8750, CSA250 UL2108, 67.1.9, 60.4, CSA C22.2 #9
Driver	Remote (Sold Separately)
Temperature Ratings	Operating / Startup: -20° to 48°C (-4° to 120°F) Storage: -40° to 76°C (-40° to 170°F)
Installation Link	

ELECTRICAL

Dimming	0-10V, DMX, DALI
Luminaire Voltage	120V - 277V (UNV)

MINIMUM & MAXIMUM RUNS

Wattage	1.5W	2W	3W	4W	5W	6W	8W	10W	12W
0-10V & DALI Minimum Run	4'	3'	2'	2'	2'	1'	1'	1'	1'
0-10V & DALI Maximum Run	39'	27'	19'	14'	11'	9'	7'	6'	5'
DMX Minimum Run	4'	3'	2'	2'	2'	1'	1'	1'	1'
DMX Maximum Run	26'	18'	13'	9'	8'	6'	4'	4'	3'

MOUNTING OPTION

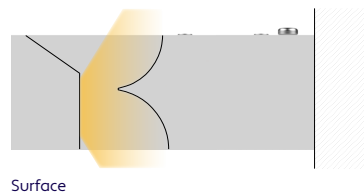

PRODUCT INFORMATION

- Lighting for accent, cove, edge, under cabinet lighting
- 24 Volts DC for easy and safe installation
- Long life, energy efficient LEDs
- Choose from a variety of LED colors and whites
- Can be ordered to specific lengths for when exact dimensions are known
Example: 10 x 10'6"
- Product is shipped in 8' max luminaires
- Different mounting options available (custom mounting available upon request)

ELECTRICAL REQUIREMENTS

- Luminaires require a 24 Volt DC remote driver.
- To calculate driver size, determine Watts per Foot.
Example: 10W per Foot
- Determine Length in Feet.
Example: 4'5"
- Calculate Load: Multiply Watts per Foot x Length in Feet
Example: 10W x 4'5"= 45W
- Choose a driver from catalog.
Example: 60 Watt Driver
- Determine maximum driver distance using Maximum Wire Length Table on drivers page.
Example: 45 watts is between 40W and 60W. Using #14 wire, maximum distance is 37' from driver to first LED.

INSTALLATION TOOLS REQUIRED

- Electric Hammer Drill
- 14.4 to 28 Volt Cordless Drill
- Phillips Bits
- Utility Knife
- Electrical Cord
- Marker
- Wire Stripper
- Long Nose Pliers
- Drill Bits - Concrete or Wood
- Electrical Three Ways
- Safety Glasses
- Measuring Tape
- Laser Line or Chalk Line

WARNING

When using luminaires for any application, basic safety precautions should always be followed to reduce the risk of fire, electric shock, and personal injury. Luminaires must be installed in accordance with the NEC or CEC as applicable. ALUZ will not be responsible for damage or malfunction caused by the following:

- Ensure power is off before installation begins, during replacements, additions, or repairs.
- Do not use luminaires if damaged, such as broken boards, loose connections, or frayed wire insulation. Inspect before installing.
- Do not install luminaires in hazardous locations.
- Do not cover luminaires with any material. Covering may cause LEDs to overheat, melt, or ignite.
- Do not paint on or over fixture lens or LEDs.
Paint or any other substance on lens or LEDs will cause a shift in color temperature.
- Soffit must be evenly painted with a neutral white to avoid color shift.
- Do not modify luminaires in the field.
- Do not overlap luminaires in any way. (Fig. 1)
- Luminaires have line voltage risk of shock. Consult factory for any malfunctions. Do not attempt to repair.
- Only use luminaire with specified rated voltages. Do not exceed the specified voltage for any luminaire.
- Do not use extrusion as a raceway for additional wire. Non-factory feed through wires inside luminaire will void warranty.
- Ground Fault Circuit Interrupter (GFCI) protections should be provided on circuits or outlets when luminaire is used for outdoor applications.
- Surge protector must be set up for electrical power system to avoid damaging lighting system.
- Do not make wiring connections without referring to wiring diagrams.
- Do not cut wire while energized. (Fig. 2)
- Do not exceed maximum run lengths.
- Always follow sequence labeling for continuous runs. Continuous run segments are labeled in alphabetical order.
- Polarity of continuous run segments must be aligned.
- Do not assemble continuous runs prior to installing into mounting clips. Each segment must be installed one by one into mounting clips. The weight of the assembled segments will put strain on junctions, causing the board, pin, or terminals to break.
- Do not install continuous runs without a mounting clip at each junction between two segments.
- Do not secure luminaire with nails or like means that might damage the wiring inside. Only secure by using mounting clips.
- Do not mount luminaire inside tanks or enclosures of any kind.
- Do not install downward facing luminaires without set screws.
- Do not use improper screw head type on mounting clips. It will cause the mounting clip to open up and become dysfunctional.
- Do not modify mounting clips.
- Do not weld mounting clips to surface. Mounting clips must be mechanically attached with screws appropriate for mounting surface and weight of luminaire.
- Do not mount fixture with less than the minimum number of mounting clips required. See mounting clips section for details.
- Do not install mounting clips on uneven surfaces. Use shims to level out height of mounting clips if necessary.
- Do not install mounting clips after luminaires have been assembled. Install mounting clips first, then install luminaire into mounting clips.
- Do not force luminaire into a space that is too small.
- Do not force luminaire with cord grip into soffit. (Fig. 3)
- Do not install luminaire at an angle within a cove. Only install fixtures straight within a cove. (Fig. 4)
- Do not bend extrusion around radius.
- Do not submerge dry or wet location luminaire in any liquid.
- Do not install wet location in outdoor coves without proper drainage. (Fig. 5)
- Do not install luminaire in any area that is continuously exposed to flowing or pooling water, such as underneath drain pipes, sprinklers, fountains, misters, etc.
- Do not cut, puncture, or penetrate aluminum housing, end caps, or lens covers.
- Do not drop, bang, or rest weight upon luminaire.
- Do not apply excessive pressure to any part of luminaire.
- Do not remove end caps from luminaire.
- Do not bend power cord or continuous connector past permitted bend radius. Bending past permitted bend radius will break the seal of the cordgrip or damage the insulation. (Fig. 6)
- Wet Location: 3.5" minimum bend radius
- Dry Location: 1.5" minimum bend radius
- Do not install in places where the power cord is subject to continuous flexing.
- Do not twist continuous connector or power cord.
- Do not hold, carry, or suspend luminaire by the power cord.
- Do not install on ceilings without mounting clips and set screws. (Fig. 7)

FIGURES

Figure 1

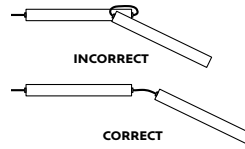

Figure 2

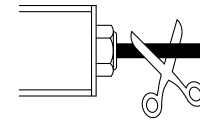

Figure 3

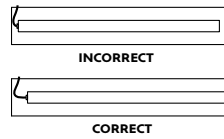

Figure 4

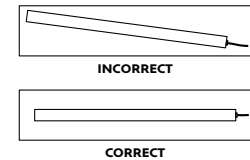

Figure 5

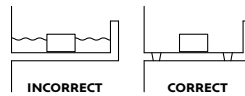

Figure 6

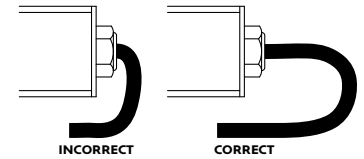
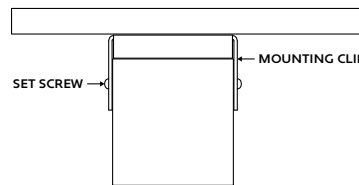

Figure 7



CLEANING MATERIALS

The use of solvents and/or cleaners which are not compatible with polycarbonate will result in the softening, crazing, and/or cracking of the plastic part. This is especially true of polycarbonate lamps and mounting bases which may be under stress in their normal applications.

COMPATIBLE WITH POLYCARBONATE

- Mild soap and water
- Mineral Spirits
- Isobutyl Alcohol
- VM and P Naphtha
- Varsol No.2
- Mexane
- Freone TF and TE-35
- Ethanol
- Dirtex
- 2% Sol. Reg. Joy
- 10% Sol Bon Ami
- White Kerosene
- Methyl Alcohol
- Heptane
- Petroleum Ether / 65°C
- Isopropyl Alcohol
- Lacryl PCL-2035
- Polycarbonate Cleaner

NOT COMPATIBLE WITH POLYCARBONATE

- Trichlor
- Gasoline
- Liquid Detergents
- Acetone
- Carbon Tetrachloride
- Pink Lux (Phosphate free)
- Triclene
- Chlorinated Hydrocarbons
- #1 & #3 Denatured Alcohol
- Methyl Ethyl Keytone (MEK)
- Texize-8006, 8129, 8758
- MIBK
- Liquid Cleaner - 8211
- Toluol
- Agitene
- Benzol
- Ajax
- Kleenol Plastics
- Lysol
- Stanisol Naphtha
- Oils
- Lemon Joy (phosphate free)
- Diversol
- Lestoil

REMOTE DRIVER WIRING

0-10V Typical Layout

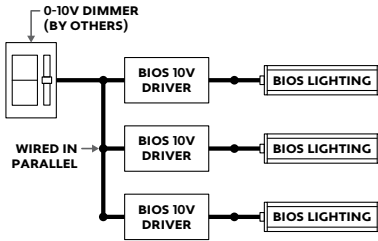

0-10V Wiring

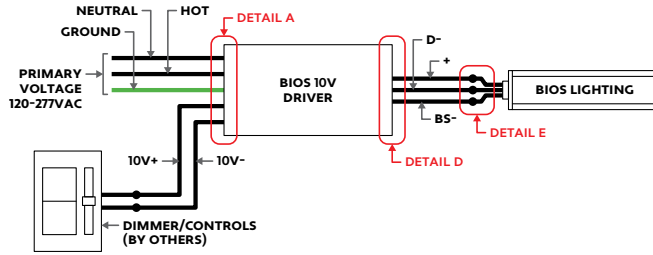

DALI Typical Layout

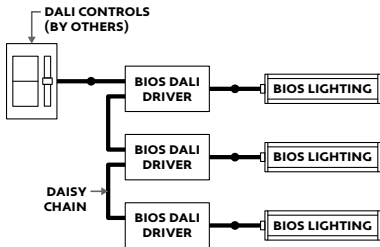

DALI Wiring

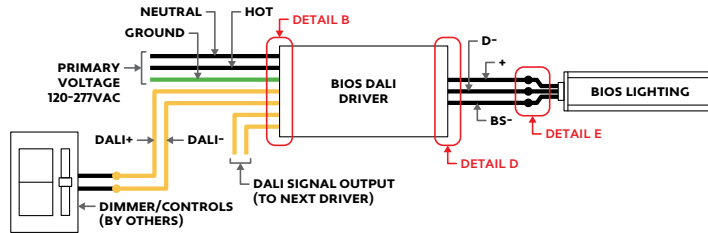

DMX Typical Layout

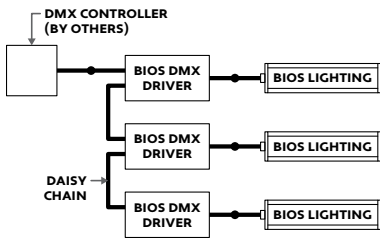

DMX Dimming

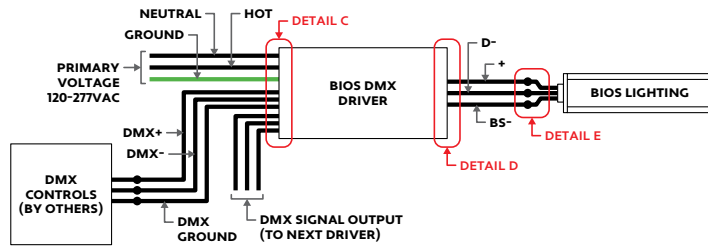

WIRING DETAILS

Detail A: 10V Driver Input

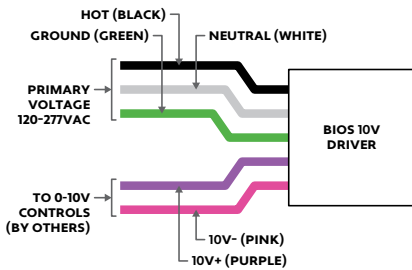

Detail B: DALI Driver Input

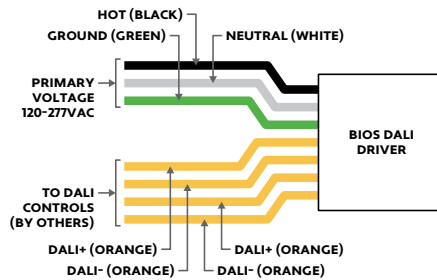

Detail C: DMX Driver Input

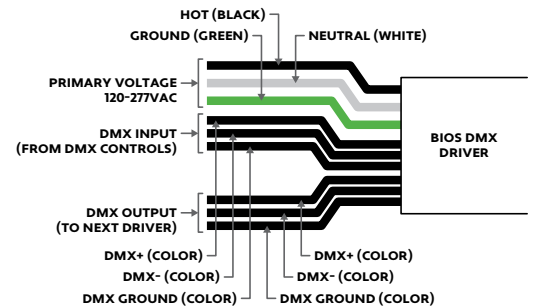

Detail D: Driver Output

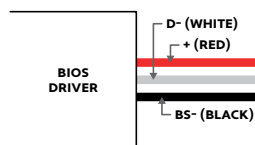

Detail E: Fixture Wiring

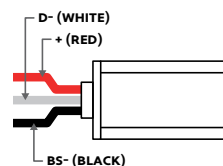

- 1 Measure area where luminaires will be installed. Use a laser line to create a reference line along installation area, ensuring consistent alignment of luminaire segments.
- 2 The luminaire must be mounted to a solid surface, such as wood or metal. The luminaire may be mounted directly to a surface or mounted through drywall. The mounting surface must be capable of supporting the weight of the luminaires.
- 3 Determine number of Mounting Brackets needed. Use 1 bracket per 2' or 4 brackets per 8' luminaire segment. Space the brackets evenly.

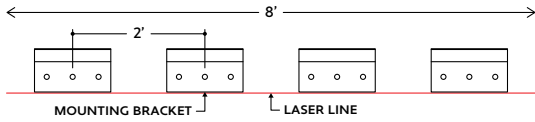

- 4 Use the diagram below to determine how much space is needed to mount the luminaire.

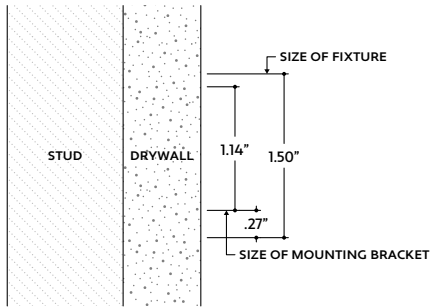

- 5 Secure the Mounting Bracket to surface with the angled portion pointing up. Use appropriate screws for the surface material and weight of luminaire.

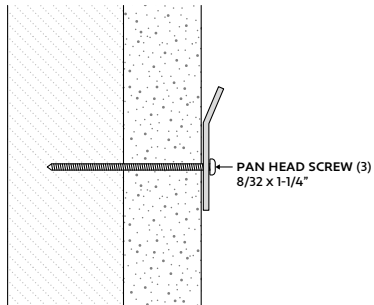

- 6 Hang luminaires onto brackets according to the diagram below. Ensure each segment is properly hooked to the bracket, then check levelness.

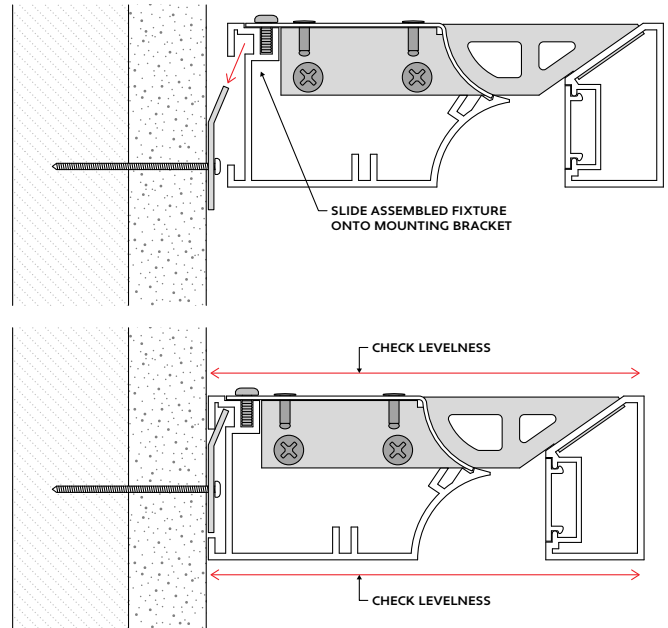

TROUBLESHOOTING TIPS

- Do not reset the breaker multiple times.
- If the unit is overloaded, the breaker will trip, shutting off the driver and lights.
- If the breaker reset button has been held down by hand or any type of pressure, such as duct tape, or if the breaker has been reset multiple times without troubleshooting, the unit will:
 - Burn the driver bobbin.
 - Burn the thermal or magnetic breaker.
 - Burn the driver lead wires due to high amperage caused by overload.
 - Short circuit in line which will not allow the breaker to reset.
 - Damage the lighting.

1 Turn off power before beginning. Verify power is off by using a not contact circuit tester (by others).

2 Check the board for damage, such as cuts, punctures, twisting, or crushing. If there is excessive damage to the board, it must be replaced.

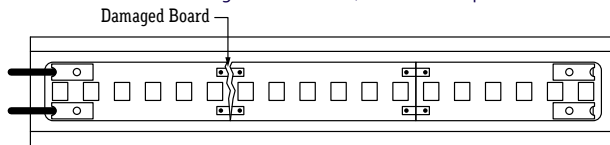

3 Check the run for any particles that may cause a short. Check the end cap, power connector, and board for any metal flakes or shavings. Clear the run of any shavings or particles if present, then perform a continuity test to confirm the short has been eliminated.

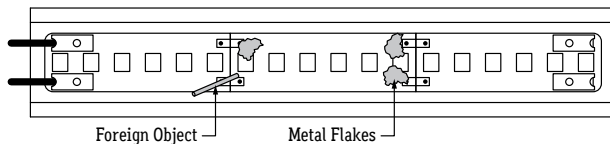

4 Check board cuts to ensure they are clean. Frayed, split, or sloppily cut boards can damage the circuit, resulting in flickering, dimness, or LED outages.

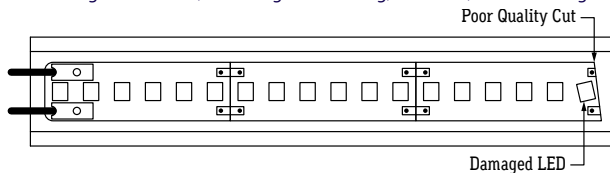

5 Check terminal connections between LED boards. If a terminal is loose, damaged, or absent, the board must be replaced. Check soldered connections to LED boards, if applicable.

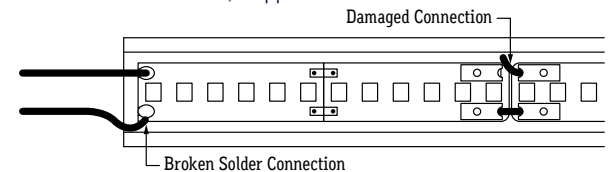

6 Check connections in the line. Ensure all splice connections are secure and properly sealed with shrink tube and silicone for outdoor applications. Ensure that wiring is not bent past the permitted wiring bend radius (1.5”).

7 Check the run for any water inside end cap, power connector, or lightstrip. If water or condensation is present, the lightstrip must be replaced.

CONTINUITY TEST

A continuity test is performed to determine if electricity can pass through two points on an electrical circuit. This helps identify shorts or malfunctions in the line or luminaire. Use a multimeter or continuity tester to perform the steps below.

- Always perform a continuity test before connecting to power source.
- Malfunctions are not always as obvious as the lights not turning on.
- A short or malfunction in the line or luminaire will cause damage over time, irreparably damaging the lighting and voiding warranty.

EXAMPLE OF MULTIMETER (BY OTHERS)

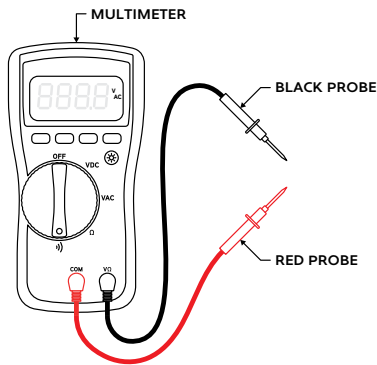

- 1 Turn off power before beginning. Verify power is off by using a non-contact circuit tester (by others). Touch the probe of the tester to the positive wire of the power source. The tester will light up if an electrical current is detected.
- 2 Setup your multimeter tester (by others). First, insert the black probe lead into the COM jack, then insert the red probe lead into the VΩ jack.

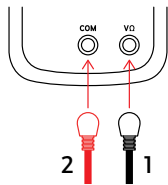

- 3 Verify multimeter is functional by touching probes together. The multimeter should beep, flash, or read 0Ω (ohms) of resistance.
- 4 Touch the red probe to the positive (+) wire and the black probe to the negative (-) wire of the luminaire. If a conductive path is formed between the positive and negative wires, the multimeter will beep, flash, or read 0Ω (ohms) of resistance. Troubleshoot to identify the malfunction in the line. If there is no conductive path formed, the multimeter will not show any feedback.

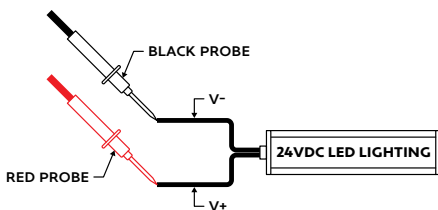

- 5 Touch the red probe to the luminaire extrusion and the black probe to the positive (+) wire. If a conductive path is formed between the extrusion and the positive wire, the multimeter will beep, flash, or read 0Ω (ohms). Troubleshoot to identify the malfunction in the line. If there is no conductive path, the multimeter will not show any feedback.

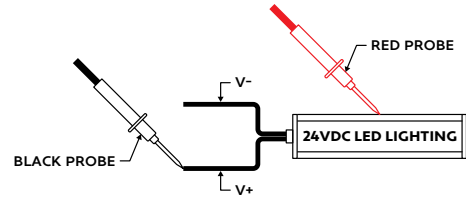

- 6 Touch the red probe to the luminaire extrusion and the black probe to the negative (-) wire. If a conductive path is formed between the extrusion and the negative wire, the multimeter will beep, flash, or read 0Ω (ohms). Troubleshoot to identify the malfunction in the line. If there is no conductive path, the multimeter will not show any feedback.

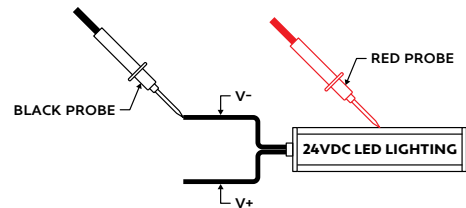

- 7 Set multimeter to DC voltage and test power source. Confirm the correct voltage before connecting luminaire to power source. If the voltage reading is more than 1 volt greater than the marked output voltage, there is a problem with the power source or driver.
- 8 Connect luminaire to power source via power connector. If LEDs do not turn on, flip the polarity (+/-) or power source connection to power connector.

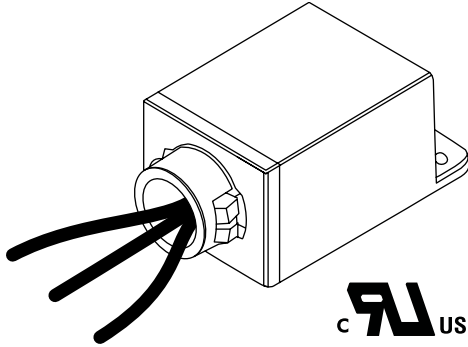

CASE DIMENSIONS

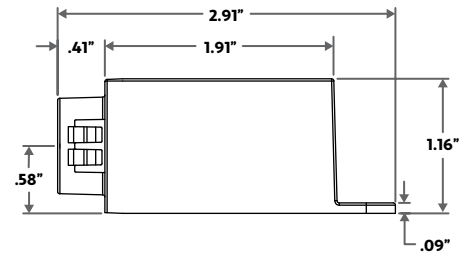
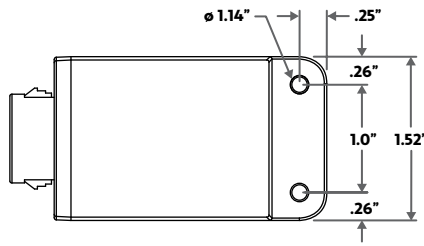

SURGE PROTECTOR SPECIFICATIONS

Model	Input Voltage	Surge Protection Level	Mounting	Enclosure Material	Input Needs	Input Frequency
ALS-SP	120V - 277V	0kV, 10kA, ANSI C62.41 Category C	SnapLOCK / Footed	Polycarbonate	6", 18AWG stranded, 105°C stripped, 3/8" tinned	60Hz

PRODUCT FEATURES

The Surge Series are 3-leaded devices that protect Line-Ground, Line-Neutral, and Neutral-Ground in accordance with IEEE / ANSI C62.41.2 guidelines. Protects against surges according to IEEE C62.41.2 C High (10kA and 10kV). Surge current rating = 10,000 Amps using industry standard 8/20 Sec wave. Surge Location Rated Category C3. UL Recognized Component in the United States and Canada (UL1449). Type 4 Surge Protection Device. High temperature, flame retardant plastic enclosure, 85°C maximum surface temperature rating. Thermally Protected Transient Over-voltage Circuit.

PRODUCT SPECIFICATIONS

The Surge series of products are designed to be used in conjunction with LED Drivers and fixtures to provide an additional level of protection against powerline disturbances in industrial, commercial and residential applications where surge protection to IEEE C62.41.2 is required.

0-10V WIRING DIMMING DIAGRAM

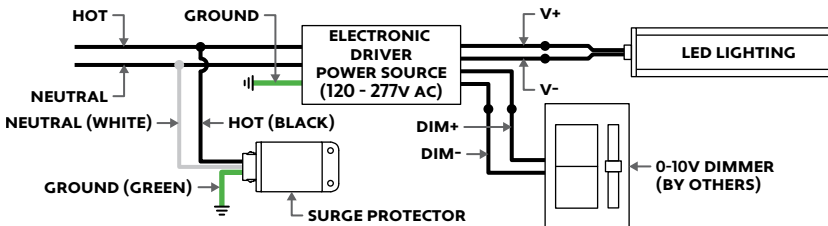

FORWARD / REVERSE PHASE DIMMING WIRING DIAGRAM

