

READ ENTIRE GUIDE BEFORE STARTING INSTALLATION

Important Notice: Verify correct luminaire was received with correct color temperature, voltage, and wattage before cutting or installing. ALUZ will not be responsible if incorrect luminaire is installed.

END VIEWS / DIMENSIONS

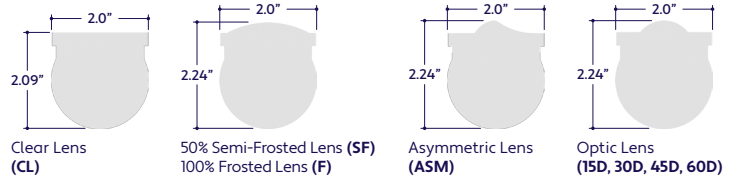

GENERAL FEATURES

Applications	Indirect and Direct Lighting
Lens	Clear, 50% Semi-Frosted, or 100% Frosted
Optics & Asymmetric	15°, 30°, 45°, 60° or Asymmetric Optics
Length	Built to Order (+/- 1/8 Tolerance) (1' Minimum Length, 2' Minimum Length for DMX or DALI Dimming)
Construction	Aluminum Extrusion
Weight	0.95 lbs per foot
Mounting	Mounting Clips (Sold Separately)
Listing	Dry, Wet, or IP67 Location UL1598, CSA C22.2#250.0 UL8750, CSA250 UL2108, 67.1.9, 60.4, CSA C22.2 #9
Closest Rating	Up to 3.6 Watts per Foot Maximum
Temperature Ratings	Operating / Startup: -20° to 48°C (-4° to 120°F) Storage: -40° to 76°C (-40° to 170°F)
Installation Link	

ELECTRICAL

Dimming	0-10V, Forward Phase, DMX, DALI
Maximum Run (Line Voltage Integral Driver)	100' (1.5W, 2W, 3W), 80' (4W), 64' (5W), 53' (6W), 40' (8W), 26' (12W)
Luminaire Voltage	120V - 277V (UNV) 120V (Forward Phase Dimming Only)

PRODUCT INFORMATION

- Lighting for accent, cove, edge, display, or under cabinet
- Line Voltage or Low Voltage (integral or remote driver)
- Long life, energy efficient LEDs
- Choose from a variety of LED colors and whites
- Can be ordered to specific lengths for when exact dimensions are known
Example: 10 x 10'6"
- Product is shipped in 8' maximum lengths
- Four different mounting options available

ELECTRICAL REQUIREMENTS

- Line voltage luminaires do not require a remote driver
- Low voltage luminaires require a 24 Volt DC remote driver.
- To calculate driver size, determine Watts per Foot.
Example: 1.5W per Foot
- Determine Length in Feet.
Example: 30'
- Calculate Load: Multiply Watts per Foot x Length in Feet
Example: 1.5W x 30' = 45W
- Choose a driver from catalog.
Example: 60 Watt Driver
- Determine maximum driver distance using Maximum Wire Length Table on drivers page.
Example: 45 watts is between 40W and 60W. Using #14 wire, maximum distance is 37' from driver to first LED.
- Maximum load per low voltage luminaire depends on size of driver
- Maximum load per line voltage luminaire is 320 watts per circuit
- Maximum load per low voltage luminaire depends on size of driver
Standard Output: 100 Watts Driver Maximum
Mid Output: 100 Watts Driver Maximum
High Output: 50 Watts Driver Maximum

INSTALLATION TOOLS REQUIRED

- Electric Hammer Drill
- 14.4 to 28 Volt Cordless Drill
- Phillips Bits
- Utility Knife
- Electrical Cord
- Marker
- Wire Stripper
- Long Nose Pliers
- Drill Bits - Concrete or Wood
- Electrical Three Ways
- Safety Glasses
- Measuring Tape
- Laser Line or Chalk Line

WARNING

When using luminaires for any application, basic safety precautions should always be followed to reduce the risk of fire, electric shock, and personal injury. Luminaires must be installed in accordance with the NEC or CEC as applicable. ALUZ will not be responsible for damage or malfunction caused by the following:

- Ensure power is off before installation begins, during replacements, additions, or repairs.
- Do not use luminaires if damaged, such as broken boards, loose connections, or frayed wire insulation. Inspect before installing.
- Do not install luminaires in hazardous locations.
- Do not operate outdoor luminaires during daytime hours.
- Do not cover luminaires with any material. Covering may cause LEDs to overheat, melt, or ignite.
- Do not paint on or over fixture lens or LEDs.
- Paint or any other substance on lens or LEDs will cause a shift in color temperature.
- Soffit must be evenly painted with a neutral white to avoid color shift.
- Do not modify luminaires in the field.
- Do not overlap luminaires in any way. (Fig. 1)
- Luminaires have line voltage risk of shock. Consult factory for any malfunctions. Do not attempt to repair.
- Only use luminaire with specified rated voltages. Do not exceed the specified voltage for any luminaire.
- Do not use extrusion as a raceway for additional wire. Non-factory feed through wires inside luminaire will void warranty.
- Ground Fault Circuit Interrupter (GFCI) protections should be provided on circuits or outlets when luminaire is used for outdoor applications.
- Surge protector must be set up for electrical power system to avoid damaging lighting system.
- Do not make wiring connections without referring to wiring diagrams.
- Do not cut wire while energized. (Fig. 2)
- Do not connect DC output from remote drivers in parallel. Parallel connections interfere with dimming capabilities and result in feedback that damages drivers. (Fig. 3)
- Always mount channels and mounting clips on flat, even surfaces.
- Do not exceed maximum run lengths.
- Always follow sequence labeling for continuous runs. Continuous run segments are labeled in alphabetical order.
- Polarity of continuous run segments must be aligned.
- Do not assemble continuous runs prior to installing into mounting clips. Each segment must be installed one by one into mounting clips. The weight of the assembled segments will put strain on junctions, causing the board, pin, or terminals to break.
- Do not install continuous runs without a mounting clip at each junction between two luminaire segments.
- Do not secure luminaire with nails or like means that might damage the wiring inside. Only secure by using mounting clips.
- Do not mount luminaire inside tanks or enclosures of any kind.
- Do not install downward facing luminaires without set screws.
- Do not use improper screw head type on mounting clips. It will cause the mounting clip to open up and become dysfunctional.
- Do not modify mounting clips.
- Do not weld mounting clips to surface. Mounting clips must be mechanically attached with screws appropriate for mounting surface and weight of luminaire.
- Do not mount fixture with less than the minimum number of mounting clips required. See mounting clips section for details.
- Do not install mounting clips on uneven surfaces. Use shims to level out height of mounting clips if necessary.
- Do not install mounting clips after luminaires have been assembled. Install mounting clips first, then install luminaire into mounting clips.
- Do not force luminaire into a space that is too small.
- Do not force luminaire with cord grip into soffit. (Fig. 4)
- Do not install luminaire at an angle within a cove. Only install fixtures straight within a cove. (Fig. 5)
- Do not bend extrusion around radius.
- Do not submerge dry or wet location luminaire in any liquid.
- Do not install wet location in outdoor coves without proper drainage. (Fig. 6)
- Do not install luminaire in any area that is continuously exposed to flowing or pooling water, such as underneath drain pipes, sprinklers, fountains, misters, etc.
- Do not cut, puncture, or penetrate aluminum housing, end caps, or lens covers.
- Do not drop, bang, or rest weight upon luminaire.
- Do not apply excessive pressure to any part of luminaire.
- Do not remove end caps from luminaire.
- Do not bend power cord or continuous connector past permitted bend radius. Bending past permitted bend radius will break the seal of the cord grip or damage the insulation. 3.5" minimum bend radius for Wet Location. 1.5" minimum bend radius for Dry Location (Fig. 7)
- Do not install in places where the power cord is subject to continuous flexing.
- Do not twist continuous connector or power cord.
- Do not hold, carry, or suspend luminaire by the power cord.
- Do not install on ceilings without mounting clips and set screws. (Fig. 8)

FIGURES

Figure 1

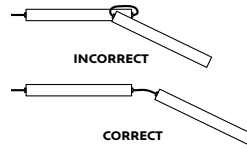

Figure 2

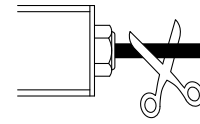

Fig. 3

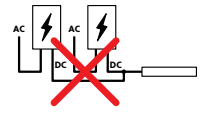

Figure 4

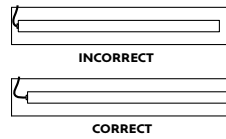

Figure 5

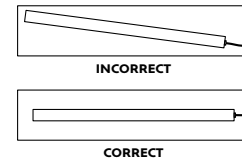

Figure 6

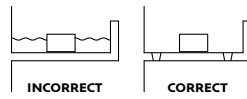

Figure 7

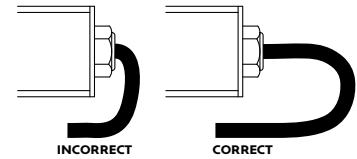
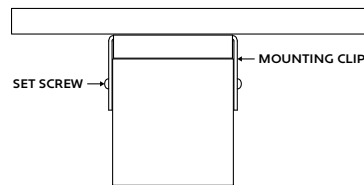

Figure 8



CLEANING MATERIALS

The use of solvents and/or cleaners which are not compatible with polycarbonate will result in the softening, crazing, and/or cracking of the plastic part. This is especially true of polycarbonate lamps and mounting bases which may be under stress in their normal applications.

COMPATIBLE WITH POLYCARBONATE

- Mild soap and water
- Mineral Spirits
- Isobutyl Alcohol
- VM and P Naphtha
- Varsol No.2
- Mexane
- Freone TF and TE-35
- Ethanol
- Dirtex
- 2% Sol. Reg. Joy
- 10% Sol Bon Ami
- White Kerosene
- Methyl Alcohol
- Heptane
- Petroleum Ether / 65°C
- Isopropyl Alcohol
- Lacryl PCL-2035
- Polycarbonate Cleaner

NOT COMPATIBLE WITH POLYCARBONATE

- Trichlor
- Gasoline
- Liquid Detergents
- Acetone
- Carbon Tetrachloride
- Pink Lux (Phosphate free)
- Triclene
- Chlorinated Hydrocarbons
- #1 & #3 Denatured Alcohol
- Methyl Ethyl Keytone (MEK)
- Texize-8006, 8129, 8758
- MIBK
- Liquid Cleaner - 8211
- Toluol
- Agitene
- Benzol
- Ajax
- Kleenol Plastics
- Lysol
- Stanisol Naphtha
- Oils
- Lemon Joy (phosphate free)
- Diversol
- Lestoil

FORWARD/REVERSE PHASE (Dry Location)

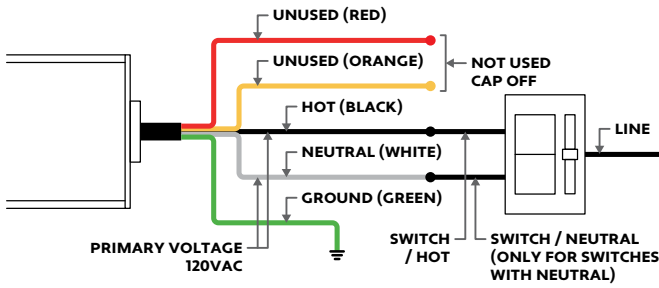

Note: 18/5 Gauge Wire. Outer jacket measures .45". Individual jackets measure .10"

FORWARD/REVERSE PHASE (Wet Location)

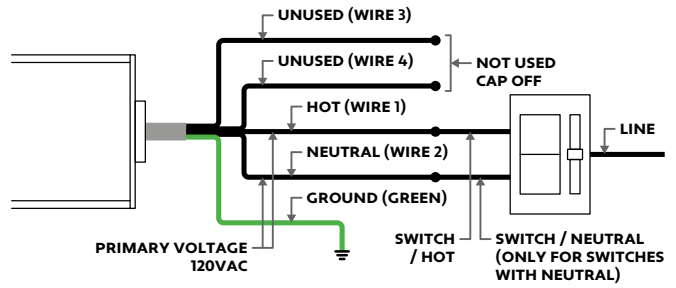

Note: 18/5 Gauge Wire. Outer jacket measures .32". Individual jackets measure .09"

120VAC

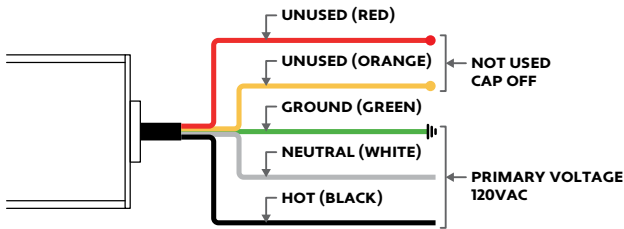

Note: 18/5 Gauge Wire. Outer jacket measures .45". Individual jackets measure .10"

120-277VAC (UNV)

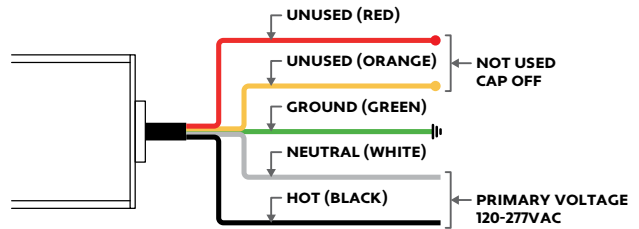

Note: 18/5 Gauge Wire. Outer jacket measures .45". Individual jackets measure .10"

0-10V (Dry Location)

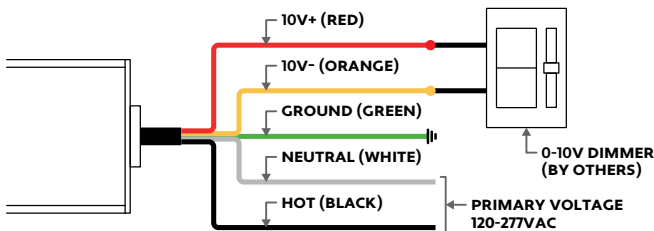

Note: 18/5 Gauge Wire. Outer jacket measures .45". Individual jackets measure .10"

0-10V (Wet Location)

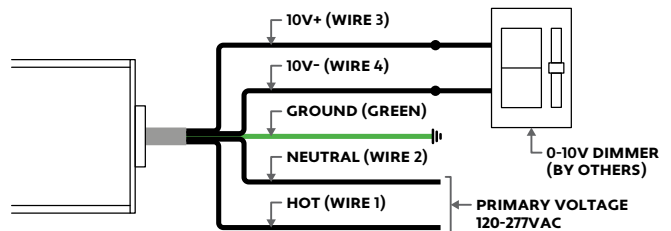

Note: 18/5 Gauge Wire. Outer jacket measures .32". Individual jackets measure .09"

DALI (Dry Location)

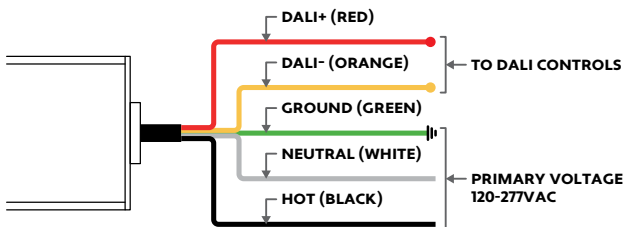

Note: 18/5 Gauge Wire. Outer jacket measures .45". Individual jackets measure .10"

DALI (Wet Location)

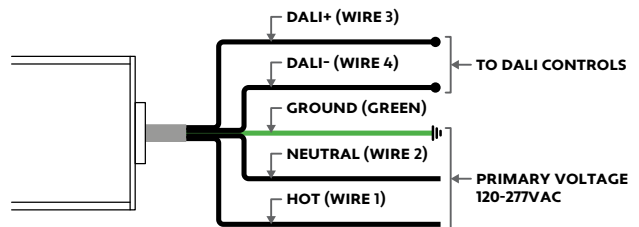

Note: 18/5 Gauge Wire. Outer jacket measures .45". Individual jackets measure .10"

DMX (Dry or Wet Location)

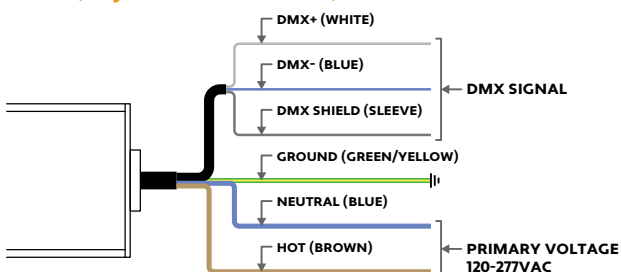

Note: 18/5 Gauge Wire. Outer jacket measures .34". Individual jackets measure .13"

Note: Verify wire colors and wiring diagram from fixture before connecting. If there is a discrepancy, consult factory before connecting.

FORWARD/REVERSE PHASE (Dry or Wet Location)

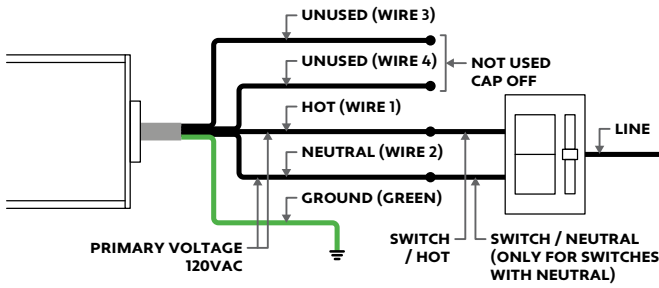

Note: 18/5 Gauge Wire. Outer jacket measures .32". Individual jackets measure .09"

120VAC (Dry or Wet Location)

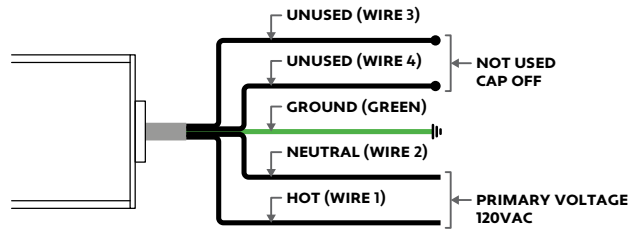

Note: 18/5 Gauge Wire. Outer jacket measures .32". Individual jackets measure .09"

120-277VAC (UNV - Dry or Wet Location)

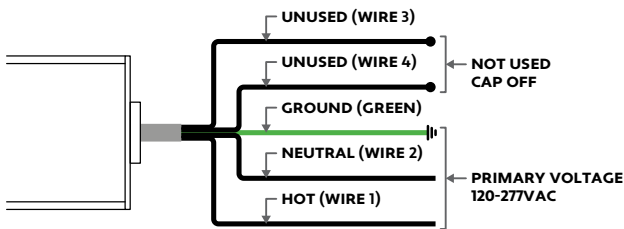

Note: 18/5 Gauge Wire. Outer jacket measures .32". Individual jackets measure .09"

0-10V (Dry or Wet Location)

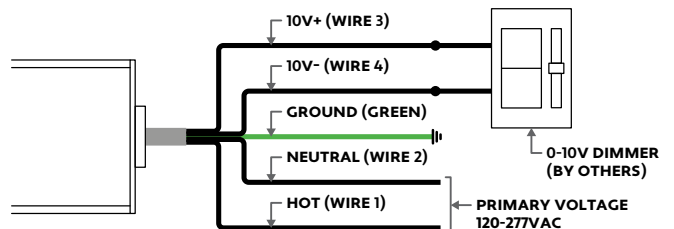

Note: 18/5 Gauge Wire. Outer jacket measures .32". Individual jackets measure .09"

DALI (Dry or Wet Location)

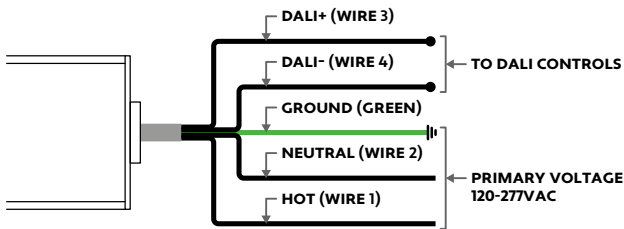

Note: 18/5 Gauge Wire. Outer jacket measures .32". Individual jackets measure .09"

Note: Verify wire colors and wiring diagram from fixture before connecting. If there is a discrepancy, consult factory before connecting.

FORWARD / REVERSE PHASE DIMMING (PH)

Technical Requirements For Control Equipment

- Magnetic Low Voltage (MLV): Magnetic (core and coil, toroidal) transformer-supplied low voltage lighting.
- Electrical Characteristic: Inductive
- Special Requirements: Symmetric cycles ($VDC \leq 2$), smooth turn off (positive and negative periods are equal for safe MLV transformer operation).
- Phase dimmers must be compatible with LED loads.

PHASE DIMMER RATINGS

The stated VA (volt-ampere) rating is the rated capacity of the dimmer which includes the magnetic transformer heat losses and the lamp load. A transformer dissipates less than 20% of the connected load as heat. The lamp load plus the transformer loss determine the dimmer capacity required. See the example below.

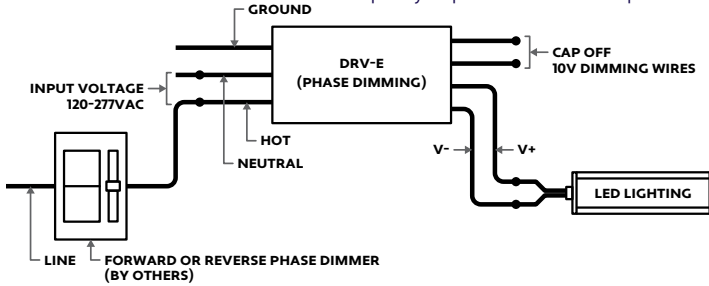

PHASE DIMMING WIRING DIAGRAM

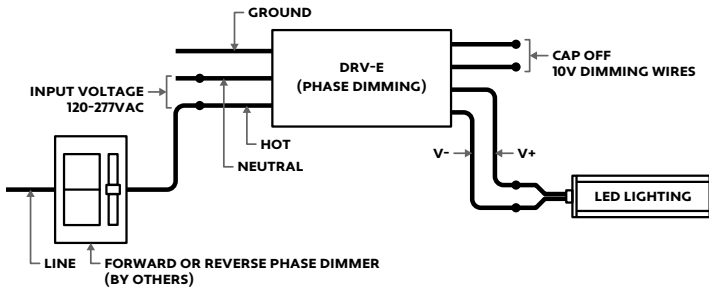

Notes: Wire colors vary based on model. See individual submittal for more information, or refer to wiring diagram on driver label. Confirm wire colors before connecting to power source. Cap off dimming wires individually for non-dimming applications. For best dimming performance, use a minimum load of 50% and a maximum load of 80%.

0-10V DIMMING (10V)

Technical Requirements For Control Equipment

- The light output of the LEDs operated by the controllable LED driver is controlled by DC voltage applied to the control input leads (gray and violet). The actual response curve of LED driver current versus control voltage.
- The control device must be capable of accepting or sinking the DC current flow from the driver. The DC current from the driver that must be sunk by the control circuit is approximately 150uA (+50% for isolated dim interfaces, up to 1.5mA for non isolated dim interfaces).
- If the control bus is opened, or if the control device internally opens the control bus under some conditions, the voltage on the control bus will then be a function of the drivers, which is 10-15V. Maximum light output will be delivered under this condition.
- If the control bus is shorted either by a mechanical switch in the control or by the circuitry of the control device, or inadvertently in the wiring, the current on the control bus will be less than 1.5mA.
- As can be determined from the two items, simple two-level operation of the drivers can be achieved by proper usage and application of a simple open/closed switch on the control bus with maximum light being achieved when the switch is open and minimum light with the switch is closed.
- The driver is intended to be used with control voltages between 0-10VDC volts peak maximum on the driver control leads.
- Control equipment intended to control more than one driver must be capable of sinking the current supplied to the control bus by the maximum number of drivers specified for the control device. At any given level setting it must maintain control bus voltage constant within a range of +/-5% as the number of drivers connected to the control bus varies from a minimum of one driver up to the maximum number specified for the control device.
- Driver of various ratings may be mixed on the same control system.

0-10V DIMMER RATINGS

The stated VA (volt-ampere) rating is the rated capacity of the dimmer which includes the electronic transformer heat losses and the lamp load. A transformer dissipates less than 20% of the connected load as heat. The lamp load plus the transformer loss determine the dimmer capacity required. See the example below.

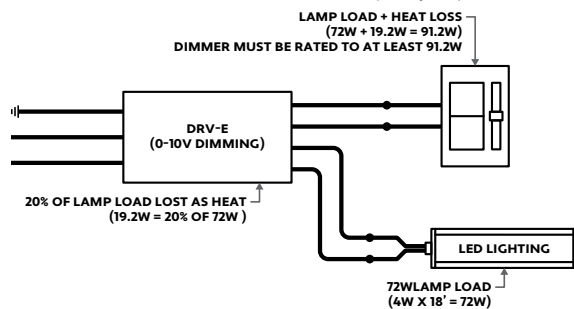

0-10V DIMMING WIRING DIAGRAM

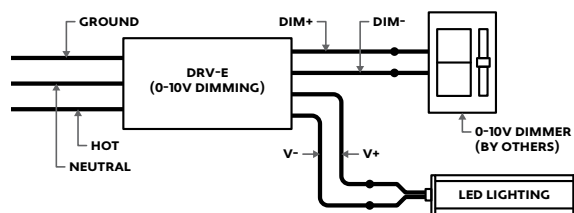

MAXIMUM RUN BASED ON 80% LOAD OF ELECTRONIC DRIVER MAXIMUM WATTAGE

Driver Wattage	80% Load	1.5W Max Run	2W Max Run	2.5W Max Run	3W Max Run	3.6W Max Run	4W Max Run	4.5W Max Run	5W Max Run	5.5W Max Run	6W Max Run	6.5W Max Run
30	24W	16'	12'	9.6'	8'	6.6'	6'	5.3'	4.8'	4.36'	4'	3.69'
60	48W	32'	24'	19.2'	16'	13.3'	12'	10.6'	9.6'	8.7'	8'	7.3'
96	76.8W	51.2'	38.4'	30.7'	25.6'	21.3'	19.2'	17.1'	15.36'	13.9'	12.8'	11.8'
150	120W	80'	60'	48'	40'	33.3'	30'	26.6'	24'	21.8'	20'	18.4'
200	160W	106.6'	80'	64'	53.3'	44.4'	40'	35.5'	32'	29'	26.6'	24.6'
300	240W	160'	120'	96'	80'	66.6'	60'	53.3'	48'	43.6'	40'	36.9'

Note: Maximum Run refers to the total length of lighting that can be connected to a single driver. Maximum Runs for individual products still apply.

MAXIMUM WIRE LENGTH TO PREVENT EXCESS VOLTAGE DROP

Wire Size	Load Wattage (W)													
	15	24	30	40	48	60	76	96	120	150	160	200	240	300
20 AWG	78'	49'	39'	31'	24'	19'	15'	12'	9'	7'	7'	5'	4'	3'
18 AWG	125'	78'	62'	49'	39'	31'	24'	19'	15'	12'	11'	9'	7'	6'
16 AWG	199'	124'	99'	78'	62'	49'	39'	31'	24'	19'	18'	14'	12'	9'
14 AWG	316'	197'	158'	125'	98'	79'	62'	49'	39'	31'	29'	23'	19'	15'
12 AWG	503'	314'	251'	199'	157'	125'	99'	78'	62'	50'	47'	37'	31'	25'
10 AWG	800'	500'	400'	316'	250'	200'	158'	125'	100'	80'	75'	60'	50'	40'
8 AWG	1273'	795'	636'	503'	397'	318'	251'	198'	159'	127'	119'	95'	79'	63'

MAXIMUM WIRING DISTANCE OF DRIVER TO LIGHTING

The maximum wiring distance of driver to LED Lighting refers to the wire used between the driver and first LED of the luminaire. If the wire gauge is inadequate for the wiring distance, the luminaire will receive decreased voltage, insufficient to power the LEDs. Refer to the table to determine appropriate wiring distances based on wire gauge and the LED load.



MOUNTING INSIDE AN ENCLOSURE

- Only mount drivers inside enclosures rated for your application
- Always ground drivers to enclosure
- Do not mount drivers without an enclosure
- Use enclosure knockouts and water-tight conduit fittings when applicable

DRIVER CARE

- Do not submerge drivers in any liquid
- Do not leave any exposed wires
- Do not cover driver without proper ventilation
- Do not install damaged driver
- Do not exceed maximum load

DIMMER TRIM VALUES

Set dimmer trim value as needed to prevent flickering and irregular dimming. Review dimmer specifications for trim value adjustment. Dimmers by others.

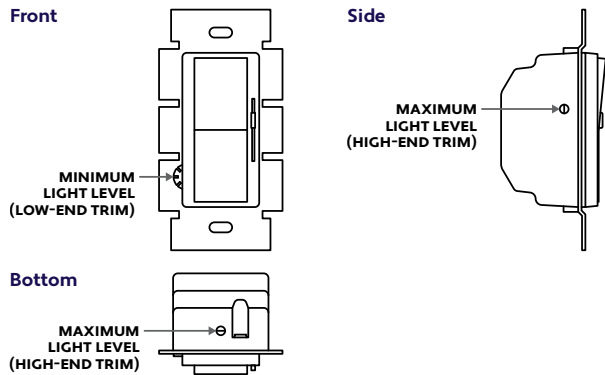

LUTRON HI-LUME 2-WIRE DIMMING (LTEA)

Technical Requirements For Control Equipment

- The Hi-lume 1% 2-Wire LED Driver (LTEA) is a high performance LED driver that provides a smooth, continuous, flicker-free 1% dimming for virtually any LED fixture. Primary voltage is 120V and secondary side is 12VDC or 24VDC. A rated life time of 50,000 hours @tc -149°F (65°C). Inrush current: < 2A. Minimum operating temperature ta = 32°F (0°C).
- Continuous, flicker-free dimming from 100% to 1%. Compatible with selected Maestro Wireless, RadioRA 2, HomeWorks QS, GRAFIK Eye QS, GRAFIK Systems, Quantum, and C-L Dimmers.
- The driver is California Title 24 JA8 Compliant.

Wiring Diagram for Controls Requiring Neutral (JA8 Compliant)

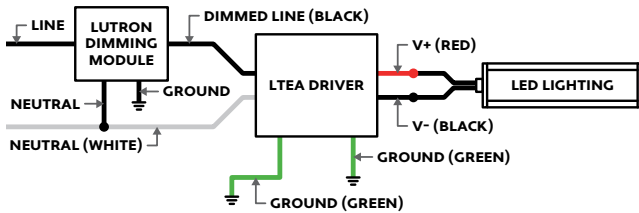

Wiring Diagram for Controls Not Requiring Neutral (JA8 Compliant)

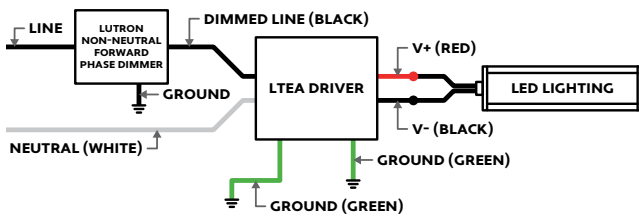

LUTRON HI-LUME 3-WIRE DIMMING (L3DA)

Technical Requirements For Control Equipment

- Hi-lume 1% EcoSystem/3-Wire Driver (L3DA) is a high-performance LED driver that provides smooth, continuous 1% dimming for virtually any LED fixture, primary voltage is 120-277 V~ at 50/60 Hz and secondary side is 12VDC or 24VDC. A rated life time of 50,000 hours @tc -149°F (65°C). Inrush current: < 2A. Minimum operating temperature ta = 32°F (0°C).
- Continuous, flicker-free dimming from 100% to 1%. Compatible with Energi Savr Node unit with EcoSystem, GRAFIK Eye QS control unit, PowPak dimming module with EcoSystem, and Quantum systems, allowing for integration into a planned or existing EcoSystem lighting control solution. Standard 3-wire, line-voltage phase control technology for consistent dimming performance.

Wiring Diagram for 3-Wire Controls

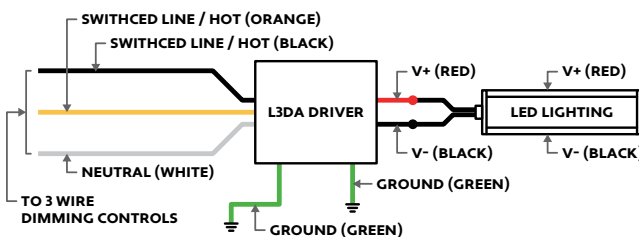

Wiring Diagram for EcoSystem Digital Controls

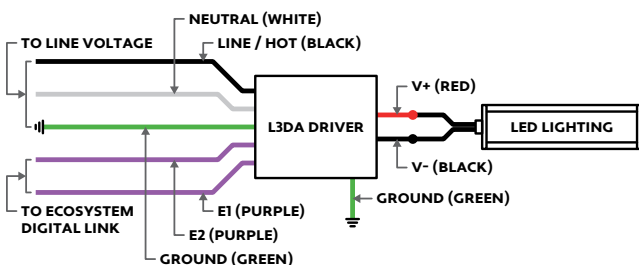

Note: Colors shown on wiring diagrams correspond to terminals on driver

LUTRON HI-LUME 3-WIRE PREMIER DIMMING (L3D0)

Technical Requirements For Control Equipment

- Hi-lume Premier 0.1% EcoSystem / 3 Wire constant voltage 24V LED driver with Soft-on, Fade-to-Black. The Hi-lume Premier 0.1% Constant Voltage Driver is a high-performance LED driver capable of controlling up to 96W of 24V constant voltage loads. This driver provides smooth and continuous dimming down to 0.1% low-end. It is ideal for use with strip lighting in applications such as coves, under or over cabinet lighting and pathway lighting. The driver is UL Listed with an integrated wiring compartment and can be mounted up to 150' away from the load.
- Continuous, flicker-free dimming from 100% to 0.1%
- Soft-on, Fade-to-Black operation for EcoSystem controls: fades smoothly between 0% and 0.1% when turned on and off for an incandescent like dimming experience.
- PWM dimming meets IEEE1789 over the entire dimming range.
- UL Listed for United States and Canada (cULus@).
- NOM certified for Mexico.
- Field Adjustment Knob offers customer low-end light output tuning for better fixture-to-fixture matching.
- Guaranteed dimming performance when used with Lutron controls:
 - HomeWorks QS, Energi Savr Node units with EcoSystem controls, GRAFIK Eye QS with EcoSystem controls, PowPak with EcoSystem dimming modules, PowPak with EcoSystem wireless fixture controls, and Quantum systems, allowing for integration into a planned or existing EcoSystem lighting control solution.
 - Lutron 3-wire controls and interfaces.
- Protected from miswires of input power, up to 277 V~, to EcoSystem control inputs.
- Rated lifetime of 50,000 hours at 40 °C (104 °F) ambient temperature and max load.
- FCC Part 15
 - Class A (277 V~)
 - Class B (120 V~)
- The driver is California Title 24 JA8 Compliant.

Wiring Diagram for 3-Wire Controls (JA8 Compliant)

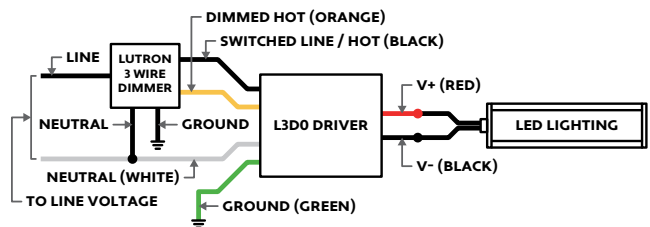

Wiring Diagram for EcoSystem Digital Controls (JA8 Compliant)

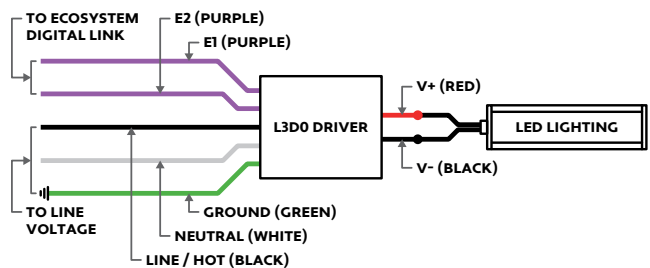
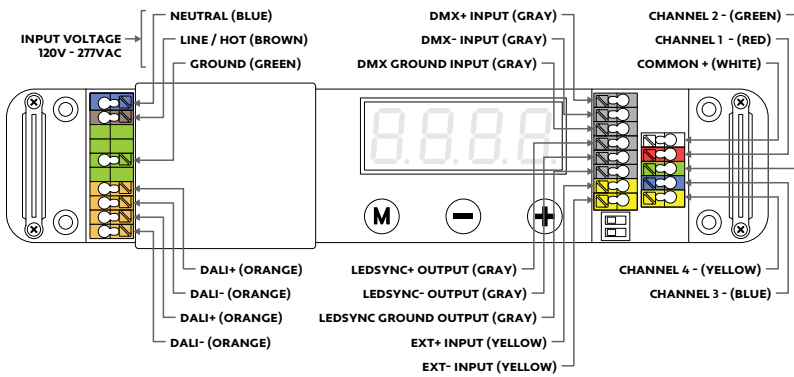
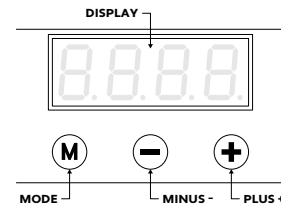

DIAGRAM OF DRIVER



DIGITAL INTERFACE



DMX NOTES

- Wire colors on diagram correspond to colors of driver terminals.
- Default DMX address of each luminaire is 001. Consult a third party DMX commissioner to modify at time of installation. ALUZ does not provide DMX commissioning.
- DMX Address must be set for each driver. Default DMX address is 001.
- A DMX Control System (by others) must be used to operate the lighting.
- The last driver in a daisy chain sequence must be terminated.
- Driver load not to exceed 100W.
- For best dimming performance, it is recommended to load drivers to a minimum of 50% (50W) and a maximum of 80% (80W).
- Up to 28 drivers may be daisy chained together using shielded cable specified for DMX wiring.
- Ensure DIP Switch 1 is set to ON (Left) to activate 24V operation.
- Do not apply voltage to any DMX wires or terminals. Only connect DMX signal wires to controllers or to DMX signal daisy chains.

DMX Daisy Chain

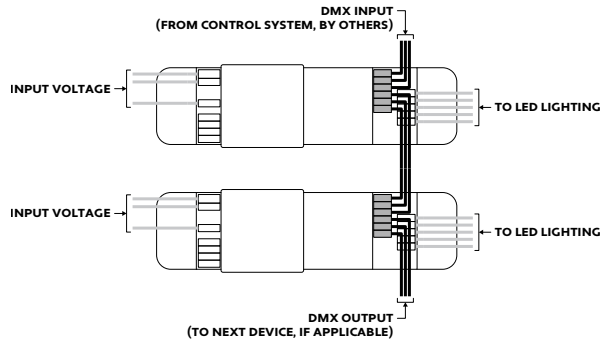

DMX Wiring: Static White

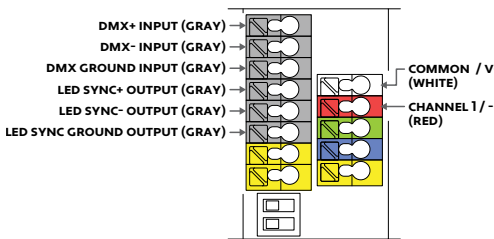

DMX Wiring: RGBW

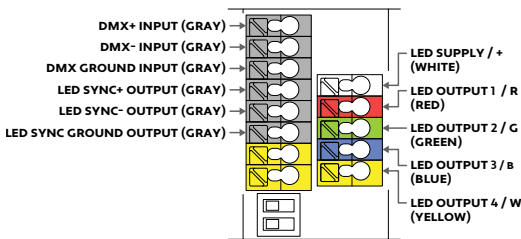

DMX Wiring: Dynamic White (DWH)

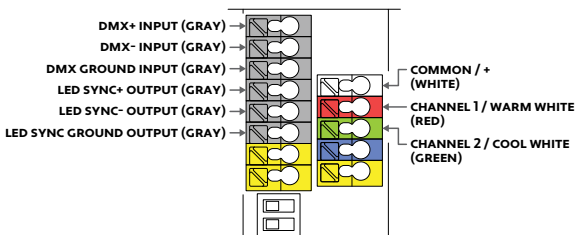

DALI NOTES

- Wire colors on diagram correspond to colors of driver terminals.
- DALI commissioning to be performed by a third party at time of installation. ALUZ does not provide DALI commissioning.
- DALI Address must be set for each driver.
- A DALI Control System (by others) must be used to operate the lighting.
- Driver load not to exceed 100W.
- For best dimming performance, it is recommended to load drivers to a minimum of 50% (50W) and a maximum of 80% (80W).
- Up to 28 drivers may be daisy chained together using shielded cable specified for DALI wiring.
- Ensure DIP Switch 1 is set to ON (Left) to activate 24V operation.

DALI Daisy Chain

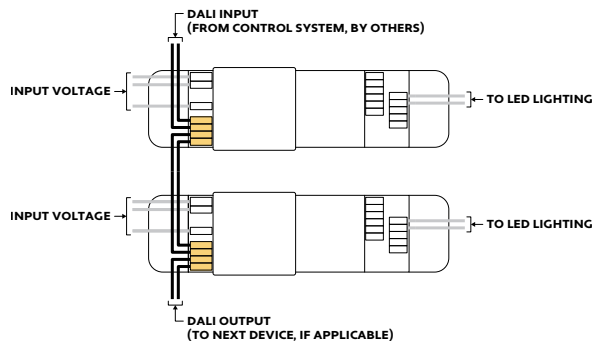

MODE OF OPERATION

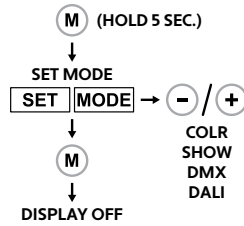

- Set Mode to DMX or DALI

SET LED GROUPS

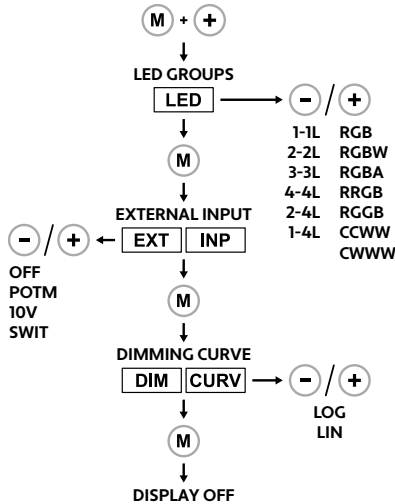

- Set LED Groups to RGBW for RGBW lighting.
- Set LED Groups to CCWW for Dynamic White lighting.
- Set LED Groups to 2-2L for Static White lighting.
- Set External Input to OFF.
- Set Dimming Curve to Linear.

STANDALONE OPERATION (Color / Show)

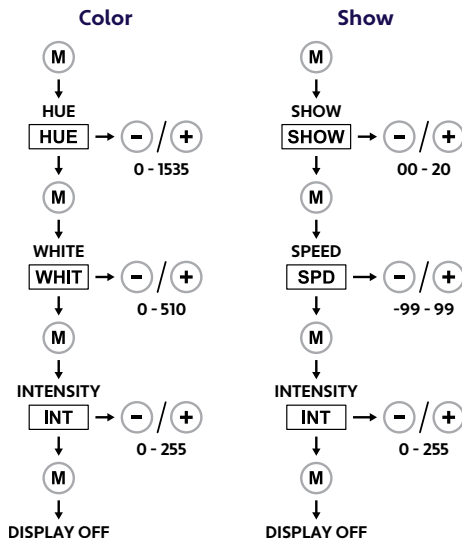

- Standalone Operation should only be used when a control system is not present to control the lighting (not recommended).

MODE OF OPERATION

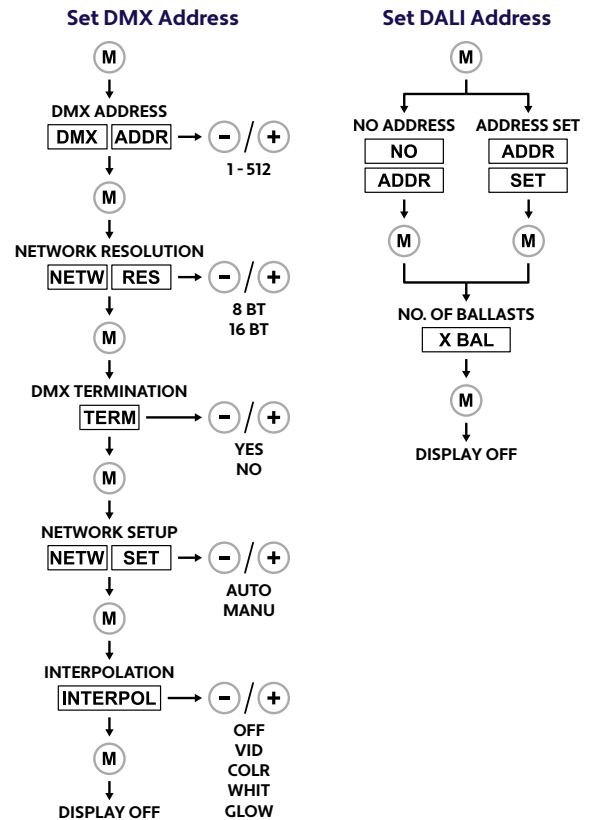

- Consult with a third-party DMX or DALI professional to determine which settings are best for your application. ALUZ does not provide DMX or DALI commissioning.

OTHER FUNCTIONS

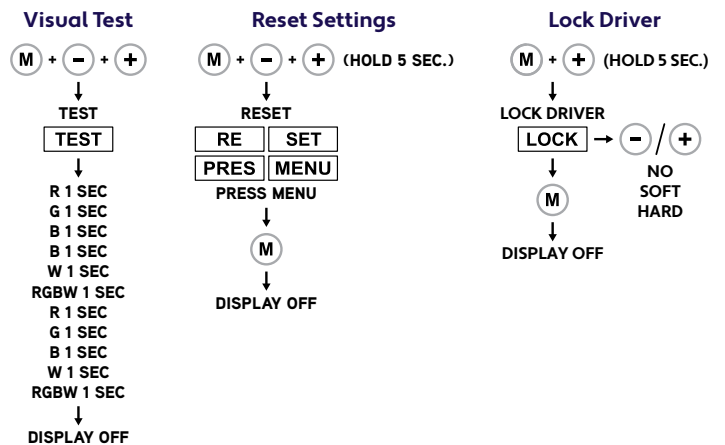

- Always perform the visual test function after wiring to ensure all channels are behaving appropriately.
- Reset driver to factory settings if necessary. It is recommended to reset each driver before adjusting settings for the first time.
- Lock driver if applicable (not recommended).

DRY LOCATION APPLICATIONS

- 1 Measure area where luminaire will be installed. Use a laser line to create a reference line along installation area, ensuring consistent alignment of mounting clips. Mark location where each mounting clip will be installed along reference line.
- 2 Use 1 mounting clip every 2', rounded up. Use a minimum of 2 mounting clips per fixture segment. For vertical applications, create a stopper at the bottom of the run to prevent sliding.
- 3 Use a mounting clip at the junction between two fixture segments.
Example: 20' Run.

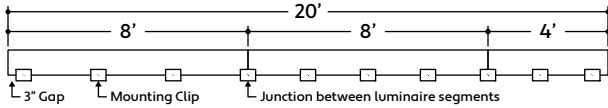

- 4 Lay mounting clips along reference line and pre-drill using an appropriate drill bit for surface material and screw size. Typical screw size is 8/32 x 1".
Note: Allow 1/4" clearance on each side of mounting clip due to lateral expansion. Only install mounting clips on flat, even surfaces.
- 5 Screw mounting clips to surface, then snap luminaire into mounting clips. Install set screws on both sides of each mounting clip, if applicable. Set screws are required for downward facing, outward facing, and vertically mounted applications.

- 5a** Screw MC-1 to surface, then snap luminaire into mounting clips.

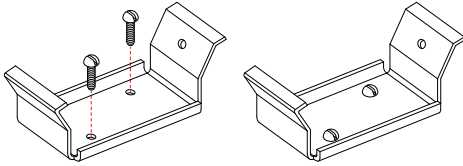

- 5b** Screw MC-2 to surface, then snap luminaire into mounting clips.

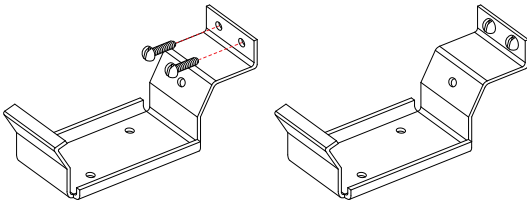

- 5c** Screw MC-3 to surface, then snap luminaire into mounting clips.

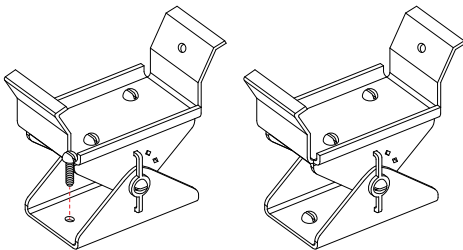

WET LOCATION APPLICATIONS

- 1 Measure area where luminaire will be installed. Use a laser line to create a reference line along installation area, ensuring consistent alignment of mounting clips. Mark location where each mounting clip will be installed along reference line.
- 2 Use 1 mounting clip every 2', rounded up. Use a minimum of 2 mounting clips per fixture segment. For vertical applications, create a stopper at the bottom of the run to prevent sliding.
- 3 Space mounting clips evenly throughout the run.
Example: 20' Run.

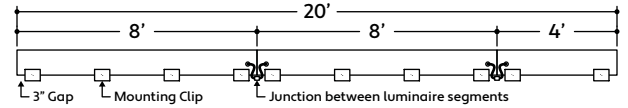

- 5d** Screw MC-4 to surface, then snap luminaire into mounting clips.

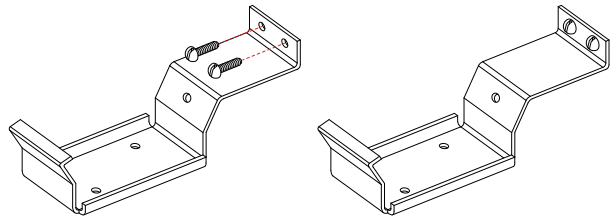

ASSEMBLED DIMENSIONS

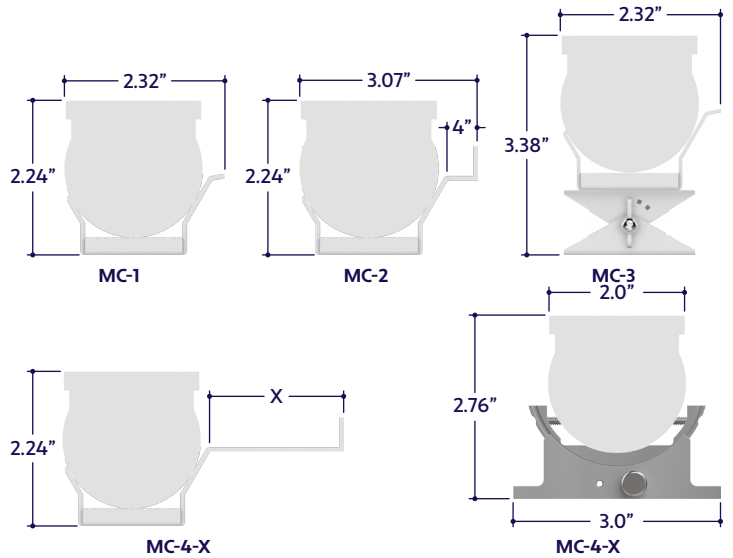

Note: Add 0.21" to overall height if using 50% Semi-Frosted, 100% Frosted, Optic, or Asymmetric Lenses.

- 1 Measure area where fixture will be installed. Use a laser line to create a reference line along installation area, ensuring consistent alignment mounting clips.
- 2 Mark location where mounting clips will be installed.
Note: The number of required mounting clips differs for dry and wet location products. Verify number of mounting clips is appropriate for installation environment before installing. Do not install fixtures with inadequate number of mounting clips
- 3 Lay mounting clips along reference line and pre-drill using an appropriate drill bit for surface and screw size.
Recommendation: 8/32 x 1" countersink screw.
Note: Allow 1/4" clearance for lateral expansion of assembled mounting clips. Only install mounting clips on flat, even surfaces.

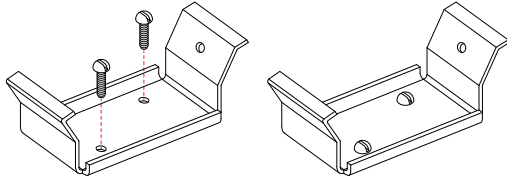

- 4 If applicable, connect disconnects between fixtures and push together, leaving no gaps. Use a mounting clip at the junction between fixture segments.

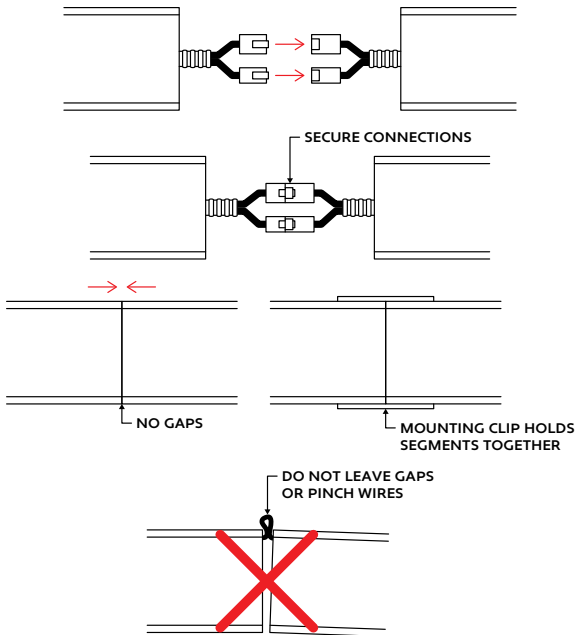

- 5 If applicable, connect jumper cable disconnects between fixtures. Install end cap screws to connect end cap to fixture.

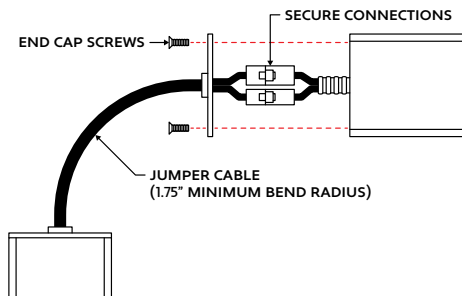

- 6 Screw mounting clips to surface, then snap fixtures into mounting clips.
Note: Set screws are required for downward and outward facing applications.

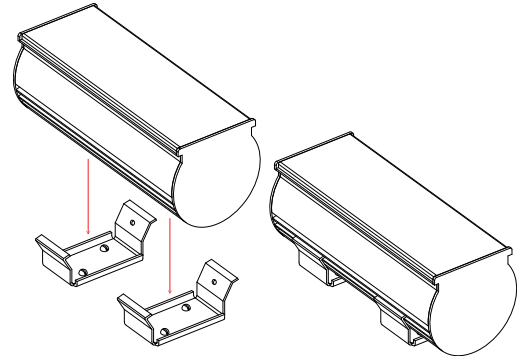

- 7 If applicable, connect power connector disconnects to fixture. Install end cap screws to connect end cap to fixture.
Note: Standard fixture provided with 1 factory installed 6' power connector and 1 end cap at the end of each run. The power connector can be easily relocated by unscrewing end cap and undoing disconnects.

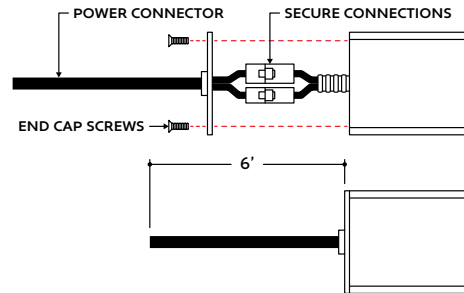

- 8 If applicable, connect power disconnects to j-box. Use power conduit for hardwiring. Connect wires using wire nuts and cap off any unused wires. Ensure connections are secure, then install end cap screws to connect end cap to fixture.
Note: Wires and conduit for hardwiring supplied by others. Wires to be determined by installer in order to identify line voltage and 0-10V signal wires.

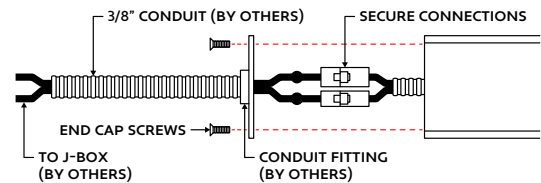

- 9 Perform a continuity test before connecting to power source.
Note: Refer to **Continuity Test** for details.

- 10 Connect fixture to power source and testing lighting and dimming functions. After lighting is confirmed to be working, replace top cover to each fixture segments, ensuring it snaps securely in place.

- 1 Measure area where fixture will be installed. Use a laser line to create a reference line along installation area, ensuring consistent alignment mounting clips.
- 2 Mark location where mounting clips will be installed.
Note: The number of required mounting clips differs for dry and wet location products. Verify number of mounting clips is appropriate for installation environment before installing. Do not install fixtures with inadequate number of mounting clips
- 3 Lay mounting clips along reference line and pre-drill using an appropriate drill bit for surface and screw size.
Recommendation: 8/32 x 1" countersink screw.
Note: Allow 1/4" clearance for lateral expansion of assembled mounting clips. Only install mounting clips on flat, even surfaces.

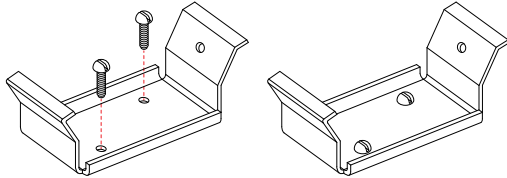

- 4 If applicable, connect continuous run disconnects between fixture segments. Slide shrink tube over connectors and apply heat. The shrink tube will shrink down and seal the connectors. Apply silicone around sealed connectors for a stronger seal.

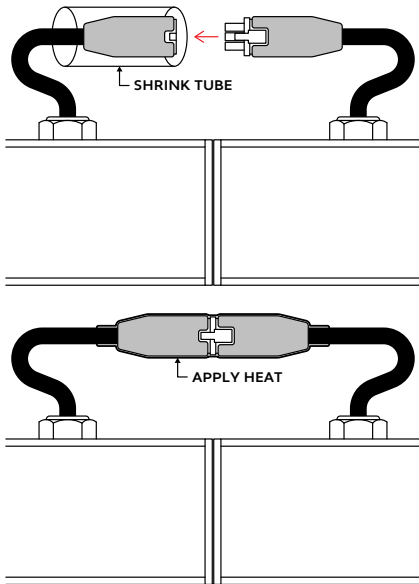

- 5 Screw mounting clips to surface, then snap fixtures into mounting clips.
Note: Set screws are required for downward and outward facing applications.

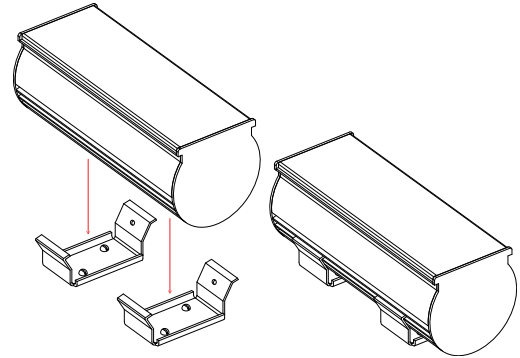

- 6 Perform a continuity test before connecting to power source.
Note: Refer to **Continuity Test** for details.
- 7 Connect fixture to power source and testing lighting and dimming functions. After lighting is confirmed to be working, replace top cover to each fixture segments, ensuring it snaps securely in place.

TROUBLESHOOTING TIPS

- Do not reset the breaker multiple times.
- If the unit is overloaded, the breaker will trip, shutting off the driver and lights.
- If the breaker reset button has been held down by hand or any type of pressure, such as duct tape, or if the breaker has been reset multiple times without troubleshooting, the unit will:
 - Burn the driver bobbin.
 - Burn the thermal or magnetic breaker.
 - Burn the driver lead wires due to high amperage caused by overload.
 - Short circuit in line which will not allow the breaker to reset.
 - Damage the lighting.

- 1 Turn off power before beginning. Check for any twisting or damage to the circuit in the LED lightstrip. If there is excessive damage and the circuit is broken, the lightstrip must be replaced.

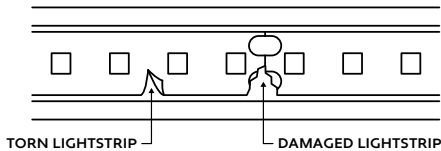

- 2 Check for metal particles or other foreign objects causing the short.

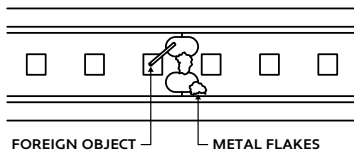

- 3 Check to make sure cuts in the lightstrip are clean and not frayed, causing positive and negative copper pads to touch.

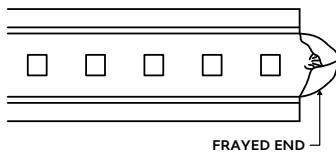

CONTINUITY TEST

A continuity test is performed to determine if electricity can pass through two points on an electrical circuit. This helps identify shorts or malfunctions in the luminaire. Use a multimeter or continuity tester to perform the steps below.

- Always perform a continuity test before connecting to power source.
- Malfunctions are not always as obvious as the lights not turning on.
- A short or malfunction in the line or luminaire will cause damage over time, irreparably damaging the lighting and voiding warranty.

- 1 Turn off power before beginning. Verify power is off by using a non-contact circuit tester (by others). Touch the probe of the tester to the positive wire of the power source. The tester will light up if an electrical current is detected.

- 2 Setup your multimeter tester (by others). First, insert the black probe lead into the COM jack, then insert the red probe lead into the VΩ jack.

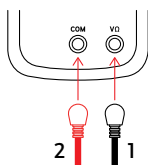

- 3 Touch the red probe to the luminaire extrusion and the black probe to the ground wire (green). If the luminaire is properly grounded, the multimeter will beep, flash, or read 0Ω (ohms). If there is no conductive path, the multimeter will not show any feedback. Troubleshoot to identify the malfunction in the ground wire.

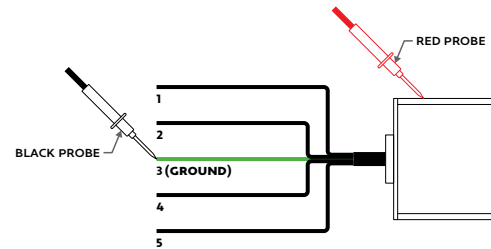

- 4 Touch the red probe to any wire and the black probe to each other wire. Repeat process for each wire. If a conductive path is formed between any of the wires, the multimeter will beep, flash, or read 0Ω (ohms). Troubleshoot to identify the malfunction in the line. If there is no conductive path, the multimeter will not show any feedback.

Example: Check for continuity between Wire 2 and Wire 4

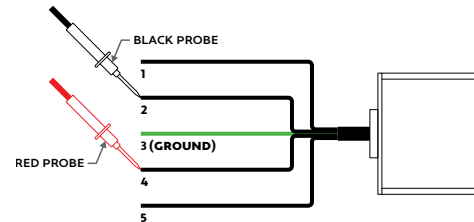

- 5 Touch the red probe to the luminaire housing and the black probe to each wire except ground. If a conductive path is formed between the housing and any of the wires, the multimeter will beep, flash, or read 0Ω (ohms). Troubleshoot to identify the malfunction in the line. If there is no conductive path, the multimeter will not show any feedback.

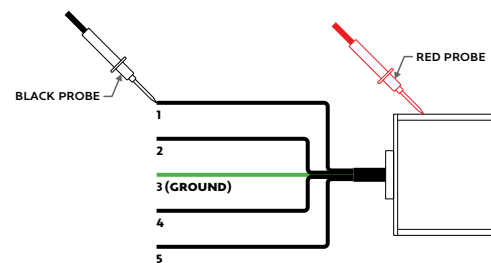

- 6 Set multimeter to AC voltage and test power source. Confirm the correct voltage before connecting luminaire to power source. If the voltage reading is more than 1 volt greater than the marked output voltage, there is a problem with the power source or driver.

- 7 Connect luminaire to power source. If LEDs do not turn on, troubleshoot to find the problem in the line.

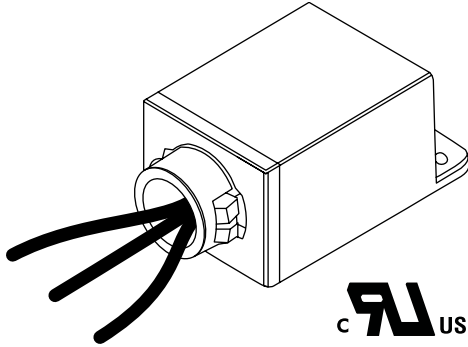

CASE DIMENSIONS

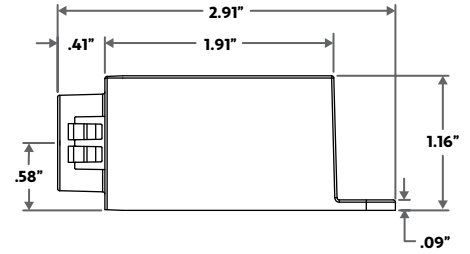
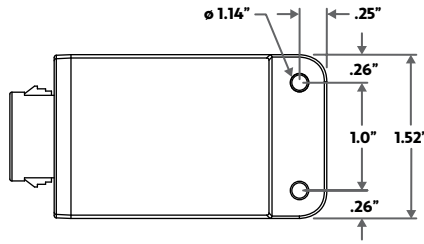

SURGE PROTECTOR SPECIFICATIONS

Model	Input Voltage	Surge Protection Level	Mounting	Enclosure Material	Input Needs	Input Frequency
ALS-SP	120V - 277V	0kV, 10kA, ANSI C62.41 Category C	SnapLOCK / Footed	Polycarbonate	6", 18AWG stranded, 105°C stripped, 3/8" tinned	60Hz

PRODUCT FEATURES

The Surge Series are 3-leaded devices that protect Line-Ground, Line-Neutral, and Neutral-Ground in accordance with IEEE / ANSI C62.41.2 guidelines. Protects against surges according to IEEE C62.41.2 C High (10kA and 10kV). Surge current rating = 10,000 Amps using industry standard 8/20 Sec wave. Surge Location Rated Category C3. UL Recognized Component in the United States and Canada (UL1449). Type 4 Surge Protection Device. High temperature, flame retardant plastic enclosure, 85°C maximum surface temperature rating. Thermally Protected Transient Over-voltage Circuit.

PRODUCT SPECIFICATIONS

The Surge series of products are designed to be used in conjunction with LED Drivers and fixtures to provide an additional level of protection against powerline disturbances in industrial, commercial and residential applications where surge protection to IEEE C62.41.2 is required.

0-10V WIRING DIMMING DIAGRAM

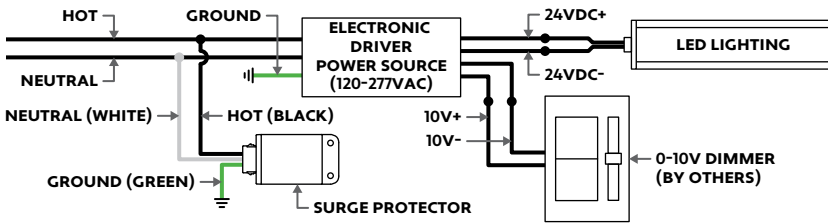

FORWARD / REVERSE PHASE DIMMING WIRING DIAGRAM

