

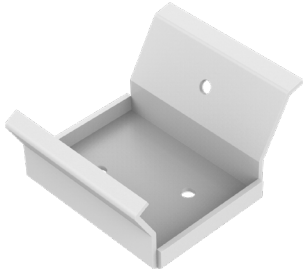

Perspective View

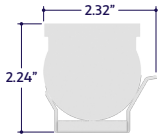

Assembled Dimensions



Clear Lens (CL)



50% Semi-Frosted Lens (SF)
100% Frosted Lens (F)

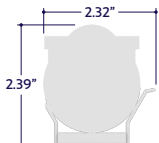

Optic Lens (15D, 30D, 45D, 60D)

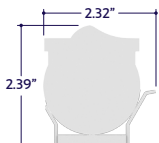

Asymmetric Lens (ASM)

DRY LOCATION APPLICATIONS

- 1 Measure area where luminaire will be installed. Use a laser line to create a reference line along installation area, ensuring consistent alignment of mounting clips. Mark location where each mounting clip will be installed along reference line.
- 2 Use 1 mounting clip every 2', rounded up. Use a minimum of 2 mounting clips per fixture segment. For vertical applications, create a stopper at the bottom of the run to prevent sliding.
- 3 Use a mounting clip at the junction between two fixture segments.
Example: 20' Run.

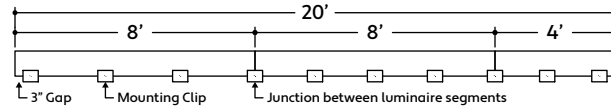

- 4 Lay mounting clips along reference line and pre-drill using an appropriate drill bit for surface material and screw size. Typical screw size is 8/32 x 1".
Note: Allow 1/4" clearance on each side of mounting clip due to lateral expansion. Only install mounting clips on flat, even surfaces.
- 5 Screw mounting clips to surface, then snap luminaire into mounting clips. Install set screws on both sides of each mounting clip, if applicable. Set screws are required for downward facing, outward facing, and vertically mounted applications.

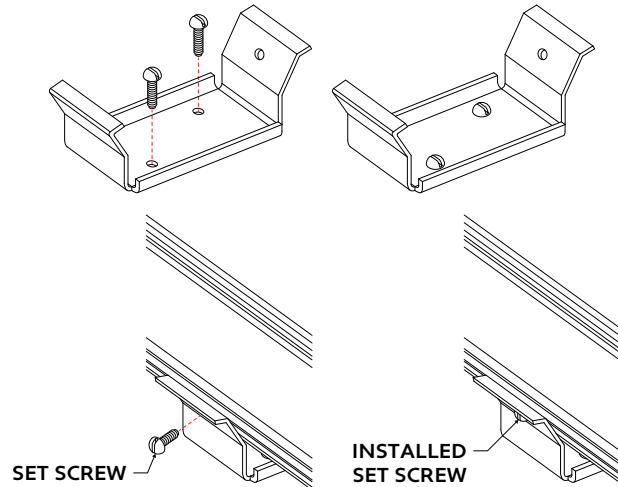

WET LOCATION APPLICATIONS

- 1 Measure area where luminaire will be installed. Use a laser line to create a reference line along installation area, ensuring consistent alignment of mounting clips. Mark location where each mounting clip will be installed along reference line.
- 2 Use 1 mounting clip every 2', rounded up. Use a minimum of 2 mounting clips per fixture segment. For vertical applications, create a stopper at the bottom of the run to prevent sliding.
- 3 Space mounting clips evenly throughout the run.
Example: 20' Run.

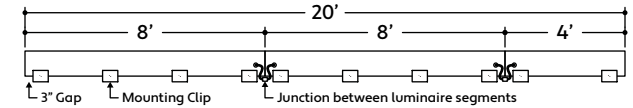

1170 N Red Gum St, Anaheim, CA 92806

aluz.lighting | info@aluz.lighting | 866.ALUZ.LTG | 714.535.7900

© ALUZ All Rights Reserved. ALUZ reserves the right to make changes or withdraw specifications without prior notice.

A1 Series | Surface ZAFU Pivot - Mounting Clip 1 (A1-ZAFU-PVT-MC-1)

This document is issued in strict confidence on condition that it is not used as a basis for manufacture or sale and is not copied, reprinted, or disclosed to a third party either wholly or in part without the prior written consent of ALUZ.

Installation Cut Sheet

Page 1 of 1

4 / 30 / 2024 / Rev 2