

END VIEWS / DIMENSIONS

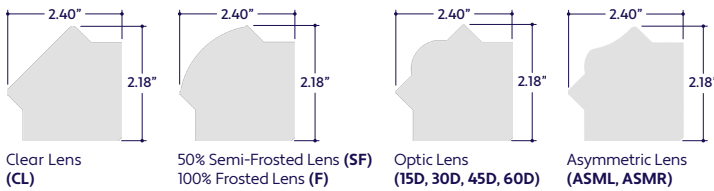

LENS / OPTICS APPEARANCE

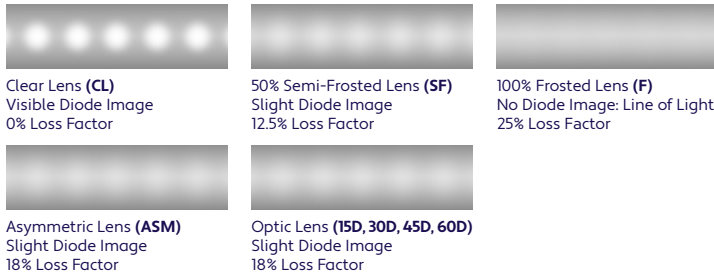

GENERAL FEATURES

Applications	Indirect and Direct Lighting
Lens	Clear, Frosted, or Semi-Frosted
Optics & Asymmetric	15°, 30°, 45°, 60° or Asymmetric Optics
Length	Built to Order (+/- 1/8 Tolerance) (1' Minimum Length, 2' Minimum Length for DMX or DALI Dimming)
Construction	Aluminum Extrusion
Weight	1.11 lbs per Foot
Mounting	Mounting Clips (Sold Separately)
Listing	Dry, Wet, or IP67 Location UL1598, CSA C22.2#250.0 UL8750, CSA250 UL2108, 67.1.9, 60.4, CSA C22.2 #9
Closet Rating	Up to 3.6 Watts per Foot Maximum
Temperature Ratings	Operating / Startup: -20° to 48°C (-4° to 120°F) Storage: -40° to 76°C (-40° to 170°F)
Installation Link	

ELECTRICAL

Dimming	0-10V, Forward Phase, DMX, DALI
Maximum Run (Line Voltage Integral Driver)	100' (1.5W, 2W, 3W), 80' (4W), 64' (5W), 53' (6W), 40' (8W), 26' (12W)
Luminaire Voltage	120V - 277V (UNV) 120V (Forward Phase Dimming Only)

SPECIFY PRODUCT CODE | CHOOSE FROM DROP DOWNS

Series	Lens / Optics	Finish	CCT LED	Watts per Foot	Dimming	Feed Point	Listing	Luminaire Voltage	Luminaire Length
A1-ZENU-STN									
ZENU Standard (A1-ZENU-STN)	Clear Lens (CL)	Natural Silver ^{#2} (NA)	2400K (24K)	1.5 Watts (1.5W) 180 Lumens / ft ³	0-10V (10V)	End Feed ^{#6} (EF)	Indoor (DRY)	120V - 277V Line Voltage ^{#7} (UNV)	Specify Length in Feet & Inches Example: 7'8"
	50% Semi-Frosted Lens (SF)	White (WH)	2700K (27K)	2 Watts (2W) 240 Lumens / ft ³	0-10V: 100% - 1% (10V-1%)	Bottom Feed (BF)			
	100% Frosted Lens (F)	Satin (SA)	3000K (30K)	3 Watts (3W) 360 Lumens / ft ³	0-10V: 100% - 1% (10V-1%)	Side Feed (SF)	Outdoor (WET)		
	Asymmetric Lens Left (ASML)	Black (BK)	3500K (35K)	4 Watts (4W) 480 Lumens / ft ³	Forward Phase: 120V Line Voltage (FP)			120V Line Voltage (Phase Dimming Only) (120V)	
	Asymmetric Lens Right ^{#1} (ASMR)	Silver (SR)	4000K (40K)	5 Watts (5W) 600 Lumens / ft ³	DMX-512 ^{#5} (DMX)		Outdoor IP67 (IP67)		
	15° Optics (15D)		4500K (45K)	6 Watts (6W) 720 Lumens / ft ³	DALI ^{#5} (DALI)				
	30° Optics (30D)		5000K (50K)	8 Watts (8W) 960 Lumens / ft ³	JAB 0-10V (JA8-10V)				
	45° Optics (45D)		5700K (57K)	12 Watts (12W) 1440 Lumens / ft ³					
	60° Optics (60D)								
						Leave Blank for Non-Dimming			

Note: Maximum length for line voltage (Integral Driver) is 320 Watts per run.
Example: 320 Watts ÷ 8 Watts per Foot = 40 feet max run.

- ^{#1} Default Asymmetric Direction is Right (ASMR) if left blank.
- ^{#2} Default finish is Natural Silver (NA) if left blank.
- ^{#3} Lumens per Foot based on 35K CCT LED with Clear Lens (CL).
Example: 120 Lumens x 1.5 Watts = 180 Lumens per Foot.

- ^{#4} Default DMX address of each luminaire is 001. Consult third party DMX commissioner to modify at time of installation. 2' minimum luminaire length.
- ^{#5} DALI commissioning to be performed by a third party at time of installation. ALUZ does not provide DALI commissioning. 2' minimum luminaire length.
- ^{#6} Default feed point is End Feed (EF) if left blank.
- ^{#7} Integral drivers sized based on wattage per length.
Example: 10 feet x 3 Watts per foot = 30 Watts. Driver will be sized based on 30 Watts.

LAMP FEATURES

Lamp Type	High Output LEDs (No Mercury)
CRI	> 95
Efficacy*	120 Lumens per Watt

Note: Efficacy is based on 35K CCT LED (35K) with Clear Lens (CL).

LAMP SPECIFICATIONS

Lamp Number	Correlated Color Temperature / Description	Efficacy (Lumens per Watt)	L70 LED Life
24K	2400 Kelvin (Incandescent White)	120	60,000 hrs.
27K	2700 Kelvin (Warm White)	120	
30K	3000 Kelvin (Warm White)	120	
35K	3500 Kelvin (Neutral White)	120	
40K	4000 Kelvin (Neutral White)	120	
45K	4500 Kelvin (Neutral White)	120	40,000 hrs.
50K	5000 Kelvin (Cool White)	130	
57K	5700 Kelvin (Cool White)	130	
R	Red (621nm)	70	
G	Green (525nm)	139	
B	Blue (470nm)	40	40,000 hrs.
A	Amber (590nm)	128	

Note: The specifications Standard Output (SO), Mid Output (MO), and High Output (HO) have been replaced by a single output equivalent to High Output (HO).
To calculate Lumens per Foot, multiply Efficacy by Watts per Foot.

Example: 120 Lumens per Watt x 1.5 Watts per Foot = 180 Lumens per Foot.

FEED POINTS

Dry Location Feed Points



End Feed (EF)



Bottom Feed (BF)



Side Feed (SF)

Note: Account for the cordgrip dimensions when measuring.
Add 0.15" for (EF).
Add 0.55" for (BF) and (SF).

Wet Location Feed Points



End Feed (EF)



Bottom Feed (BF)

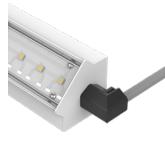

Side Feed Right (SFR)

Note: Account for the cordgrip dimensions when measuring.
Add 0.80" for (EF).
Add 1.25" for (BF) and (SF).

BEAM ANGLES

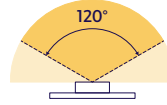

120° x 120° Beam
Clear Lens (CL)
50% Semi-Frosted Lens (SF)
100% Frosted Lens (F)

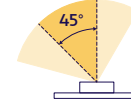

45° x 60° Beam
Asymmetric Lens Left (ASML)

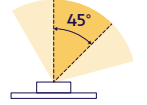

45° x 60° Beam
Asymmetric Lens Right (ASMR)

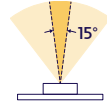

15° x 60° Beam
Optic Lens (15D)

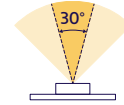

30° x 60° Beam
Optic Lens (30D)

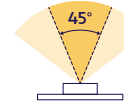

45° x 60° Beam
Optic Lens (45D)

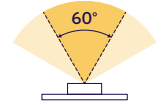

60° x 60° Beam
Optic Lens (60D)

SPECTRAL POWER DISTRIBUTION AMBER LED (590nm) TURTLE FRIENDLY

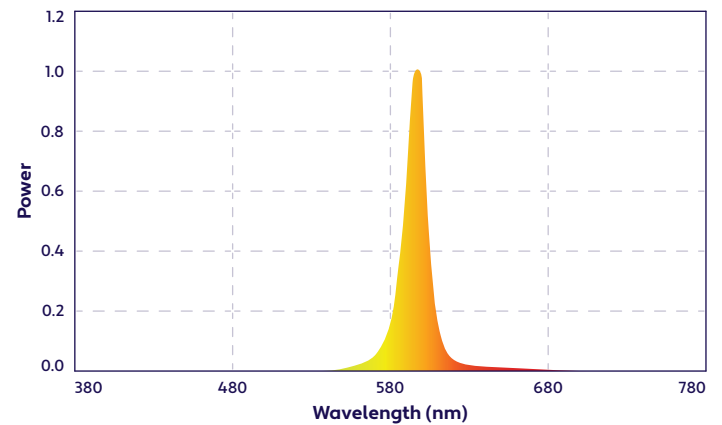

OPTICS ORIENTATION

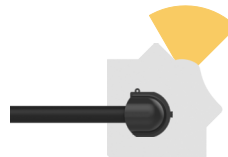

Asymmetric Lens Right (ASMR)
with Side Feed (SF)

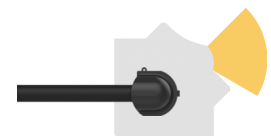

Asymmetric Lens Left (ASML)
with Side Feed (SF)

Note: Refer to the above diagrams to understand optics orientation in relation to the power feed.

MOUNTING OPTIONS (Sold Separately)

Note: Mounting clips are only available in Natural Silver Finish, unless otherwise specified.

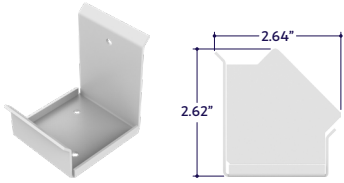

Part #	Qty.
A1-ZENU-STN-MC-1	

Note: Use 1 mounting clip per 2', rounded up.
Click on image to see cut sheet for additional details.

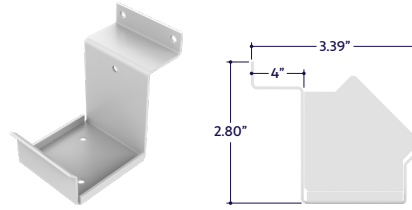

Part #	Qty.
A1-ZENU-STN-MC-2	

Note: Use 1 mounting clip per 2', rounded up.
Click on image to see cut sheet for additional details.

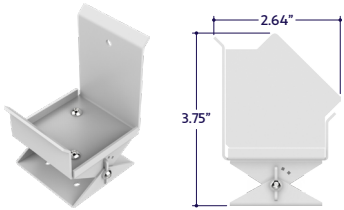

Part #	Qty.
A1-ZENU-STN-MC-3	

Note: Use 1 mounting clip per 2', rounded up.
Click on image to see cut sheet for additional details.

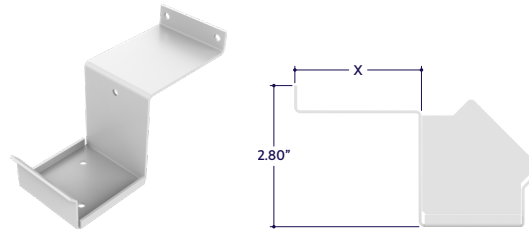

Part #	Length	Qty.
A1-ZENU-STN-MC-4-		

Note: Use 1 mounting clip per 2', rounded up.
Click on image to see cut sheet for additional details.

CONNECTORS (Sold Separately)

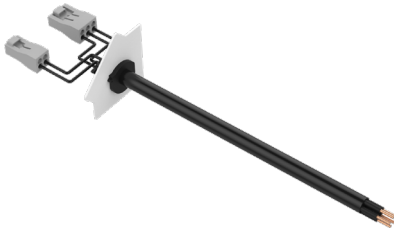

Dry Power Connector with Left End Cap
(A1-ZENU-STN-PC-ECL-Y-DRY-X)
Y = Lens / Optics
X = Specify Cable Length, 6' Default

Part #	Length	Qty.
A1-ZENU-STN-PC-ECL-CL-DRY-		
A1-ZENU-STN-PC-ECL-SF-DRY-		
A1-ZENU-STN-PC-ECL-F-DRY-		
A1-ZENU-STN-PC-ECL-ASM-DRY-		
A1-ZENU-STN-PC-ECL-15D-DRY-		
A1-ZENU-STN-PC-ECL-30D-DRY-		
A1-ZENU-STN-PC-ECL-45D-DRY-		
A1-ZENU-STN-PC-ECL-60D-DRY-		

Note: Use 1 Dry Power Connector with Left End Cap for each dry location power lead on the left side.

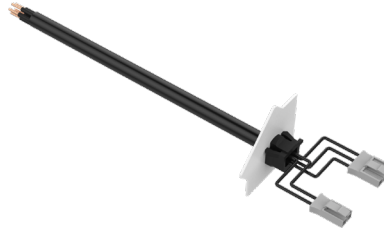

Dry Power Connector with Right End Cap
(A1-ZENU-STN-PC-ECR-Y-DRY-X)
Y = Lens / Optics
X = Specify Cable Length, 6' Default

Part #	Length	Qty.
A1-ZENU-STN-PC-ECR-CL-DRY-		
A1-ZENU-STN-PC-ECR-SF-DRY-		
A1-ZENU-STN-PC-ECR-F-DRY-		
A1-ZENU-STN-PC-ECR-ASM-DRY-		
A1-ZENU-STN-PC-ECR-15D-DRY-		
A1-ZENU-STN-PC-ECR-30D-DRY-		
A1-ZENU-STN-PC-ECR-45D-DRY-		
A1-ZENU-STN-PC-ECR-60D-DRY-		

Note: Use 1 Dry Power Connector with Right End Cap for each dry location power lead on the right side.

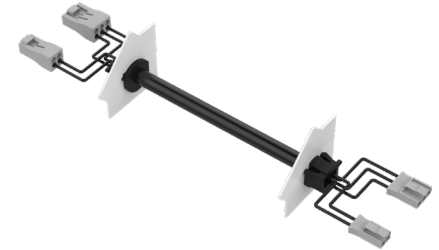

Dry Jumper Cable with End Caps
(A1-ZENU-STN-JC-EC-Y-DRY-X)
Y = Lens / Optics
X = Specify Cable Length, 6' Default

Part #	Length	Qty.
A1-ZENU-STN-JC-EC-CL-DRY-		
A1-ZENU-STN-JC-EC-SF-DRY-		
A1-ZENU-STN-JC-EC-F-DRY-		
A1-ZENU-STN-JC-EC-ASM-DRY-		
A1-ZENU-STN-JC-EC-15D-DRY-		
A1-ZENU-STN-JC-EC-30D-DRY-		
A1-ZENU-STN-JC-EC-45D-DRY-		
A1-ZENU-STN-JC-EC-60D-DRY-		

Note: Use 1 Dry Jumper Cable with End Caps for each instance where the run will transverse a corner or an obstacle.

DESIGN GUIDELINES

Individual Fixture

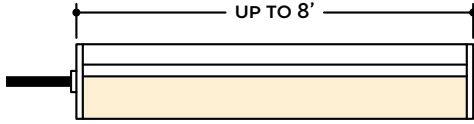

Continuous Run (Dry Location)

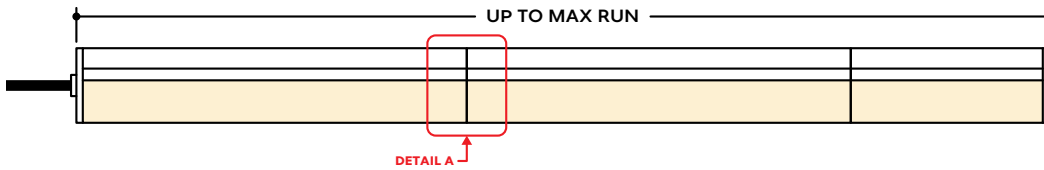

Continuous Run (Wet Location)

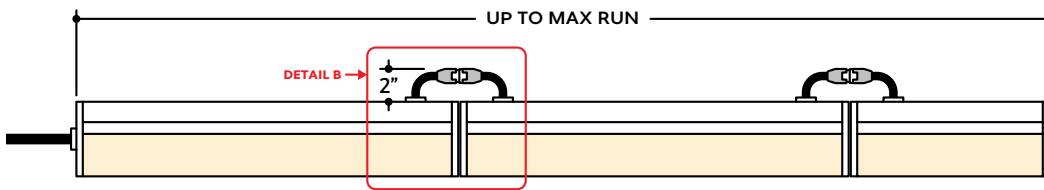

Runs with Jumper Cable (Wet Location)

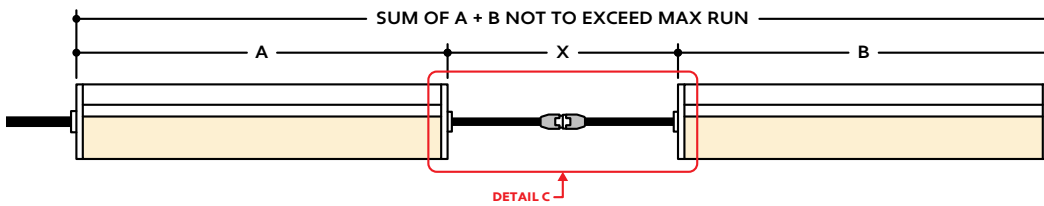

Run with Square Layout (Dry Location)

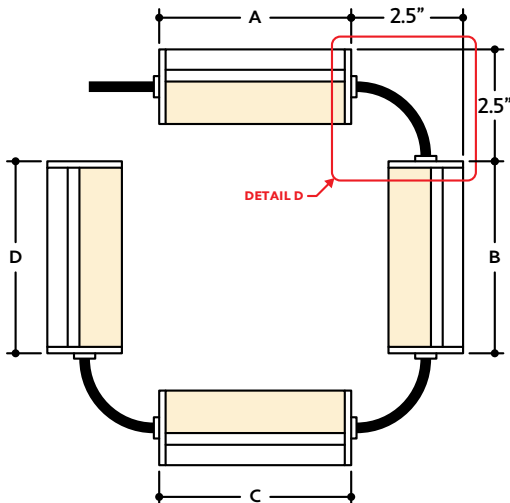

KEY

- Detail A** **Continuous Connection (Dry Location):** Fixture segments connect using internal continuous connectors, leaving no gaps between segments, with a mounting clip holding the two segments together. Refer to installation instructions for additional information.
- Detail B** **Continuous Connection (Wet Location):** Fixture segments are connected using an external continuous connector, with ends butted together. Allow at least 2" of space on the side of fixture for continuous connections. **Note:** Wet Location Continuous Connections are by default built on the right side based on fixture facing up. Consult factory for other options.
- Detail C** **Wet Jumper Cable:** Used to span a corner or traverse a gap or obstacle in a wet location installation area. Use the guidelines from Configurations to specify location of jumpers at time of order.
- Detail D** **Dry Jumper Cable:** Used to span a corner or traverse a gap or obstacle in the installation area.

Note: Drawings not to scale. Product may differ from examples shown.

CONNECTION SEQUENCE

Dry Location

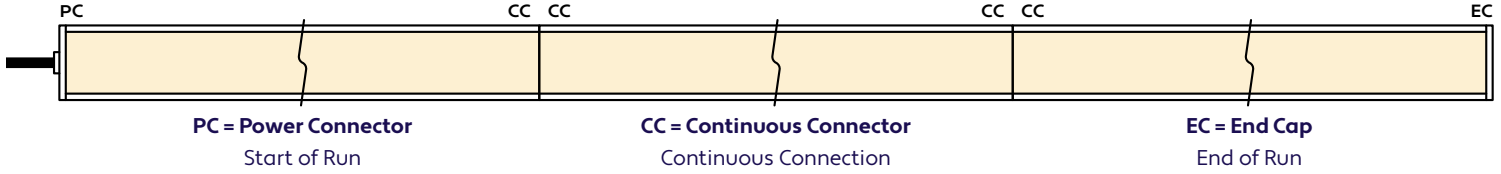

Wet Location

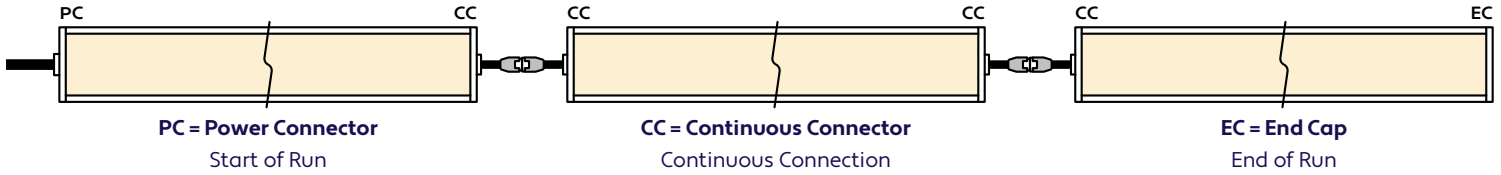

- Specifying a layout is not required to place an order.
- Configuration code applies to full length ordered and will be built per the Continuous Run models on Design Guidelines.
- Connector type subject to change based on availability and listing. Refer to Design Guidelines for details.

HOW TO SPECIFY CONFIGURATIONS

Example: 20' Straight Run

- 1x A1-ZENU-SNK-CL-NA-35K-4W-10V-EF-DRY-UNV-20'-PC-EC

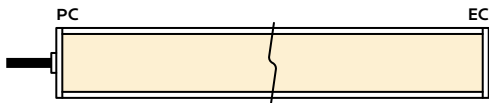

Example: 25' L-Shaped Run

- 1x A1-ZENU-SNK-CL-NA-35K-4W-10V-EF-WET-UNV-12'-PC-CC
- 1x A1-ZENU-SNK-CL-NA-35K-4W-10V-EF-WET-UNV-13'-CC-EC

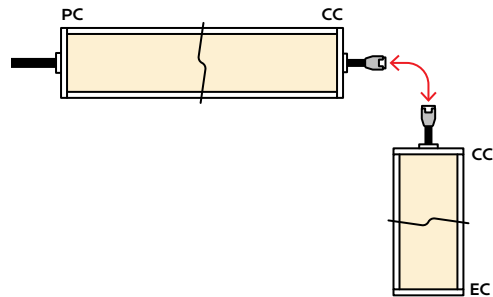

Example: 30' U-Shaped Run

- 1x A1-ZENU-SNK-CL-NA-35K-4W-10V-EF-DRY-UNV-6'-PC-CC
- 1x A1-ZENU-SNK-CL-NA-35K-4W-10V-EF-DRY-UNV-18'-CC-CC
- 1x A1-ZENU-SNK-CL-NA-35K-4W-10V-EF-DRY-UNV-6'-CC-EC

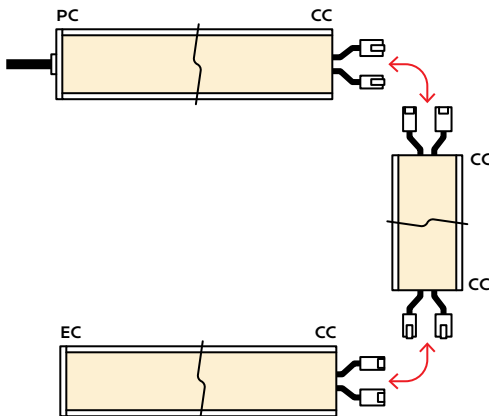

Example: 28' Rectangle Shaped Run

- 1x A1-ZENU-SNK-CL-NA-35K-4W-10V-EF-WET-UNV-11'-PC-CC
- 1x A1-ZENU-SNK-CL-NA-35K-4W-10V-EF-WET-UNV-3'-CC-CC
- 1x A1-ZENU-SNK-CL-NA-35K-4W-10V-EF-WET-UNV-11'-CC-CC
- 1x A1-ZENU-SNK-CL-NA-35K-4W-10V-EF-WET-UNV-3'-CC-EC

