

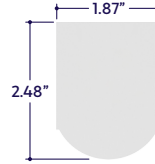

READ ENTIRE GUIDE BEFORE STARTING INSTALLATION

Important Notice: Verify correct luminaire was received with correct color temperature, voltage, and wattage before cutting or installing. ALUZ will not be responsible if incorrect luminaire is installed.

END VIEW / DIMENSIONS



GENERAL FEATURES

Applications	Direct Lighting
Lens	100% Frosted (No Pixelation: Line of Light)
Length	Standard Lengths: 4' and 8' (Seamless lengths possible with A3-ZONY-RND-SL-CC)
Construction	Aluminum Extrusion
Weight	1.32 lbs per foot
Mounting	Aircraft Cable
Listing	Dry Location UL1598, CSA C22.2#250.0 UL8750, CSA250 UL2108, CSA C22.2 #9
Driver	Integral or Remote Driver
Temperature Ratings	Operating / Startup: -20° to 48°C (-4° to 120°F) Storage: -40° to 76°C (-40° to 170°F)
Installation Link	

ELECTRICAL

Dimming	0-10V, Lutron, DMX, DALI
Maximum Run	40' (4W, 5W, 6W, 8W), 26' (12W)
Luminaire Voltage	120V - 277V (UNV)

PRODUCT INFORMATION

- Lighting for pendant mount applications.
- Line Voltage 120-277V (**UNV**) integral driver.
- Choose from a variety of LED colors and whites.
- Available in 4 Watts up to 12 Watts Per Foot.
- Can be ordered to specific lengths for easier installation.

Examples:

- 3'2" = 1 x 3'2" (Custom Length)
- 13'6" = 4' + 4' + 3' + 2'6"
- 20' = 4' + 4' + 4' + 4' + 4'
- 23'8" = 4' + 4' + 4' + 4' + 4' + 3'8"

ELECTRICAL REQUIREMENTS

- Line voltage luminaire does not require a remote driver.
- Maximum load per line voltage fixture = 320 Watts per circuit.
- A separate circuit is needed when exceeding max load per continuous run.

INSTALLATION TOOLS REQUIRED

- Electric Hammer Drill
- 14.4 to 28 Volt Cordless Drill
- Phillips Bits
- Utility Knife
- Electrical Cord
- Marker
- Wire Stripper
- Long Nose Pliers
- Drill Bits - Concrete or Wood
- Electrical Three Ways
- Safety Glasses
- Measuring Tape
- Laser Line or Chalk Line

WARNING

When using alumLEDs for any application, basic safety precautions should always be followed to reduce the risk of fire, electric shock, and personal injuries. AlumLEDs must be installed in accordance with the NEC or CEC as applicable. ALUZ will not be responsible for any damage or malfunction caused by the following:

- Ensure power is off before installation begins, during replacements, additions, or repairs.
- Do not use luminaires if damaged, such as broken boards, loose connections, or frayed wire insulation. Inspect before installing.
- Do not install luminaires in hazardous locations.
- Do not cover luminaires with any material. Covering may cause LEDs to overheat, melt, or ignite.
- Do not paint on or over fixture lens or LEDs.
Paint or any other substance on lens or LEDs will cause a shift in color temperature.
- Soffit must be evenly painted with a neutral white to avoid color shift.
- Do not modify luminaires in the field.
- Do not overlap luminaires in any way. (Fig. 1)
- Luminaires have line voltage risk of shock. Consult factory for any malfunctions. Do not attempt to repair.
- Only use luminaire with specified rated voltages. Do not exceed the specified voltage for any luminaire.
- Do not use extrusion as a raceway for additional wire. Non-factory feed through wires inside luminaire will void warranty.
- Ground Fault Circuit Interrupter (GFCI) protections should be provided on circuits or outlets when luminaire is used for outdoor applications.
- Surge protector must be set up for electrical power system to avoid damaging lighting system.
- Do not connect wires together, follow provided wiring diagrams.
- Do not cut wire while energized. (Fig. 2)
- Do not exceed maximum run lengths.
- Do not secure luminaire with nails or like means that might damage the wiring inside. Only secure by using mounting clips.
- Do not mount luminaire inside tanks or enclosures of any kind.
- Do not install downward facing luminaires without set screws.
- Do not use improper screw head type on mounting clips. It will cause the mounting clip to open up and become dysfunctional.
- Do not modify mounting clips.
- Do not mount fixture with less than the minimum number of mounting clips required. See mounting clips section for details.
- Do not force luminaire into a space that is too small.
- Do not force luminaire with cord grip into soffit. (Fig. 3)
- Do not install luminaire at an angle within a cove. Only install fixtures straight within a cove. (Fig. 4)
- Do not bend extrusion around radius.
- Do not submerge dry or wet location luminaire in any liquid.
- Do not install wet location in outdoor coves without proper drainage. (Fig. 5)
- Do not install luminaire in any area that is continuously exposed to flowing or pooling water, such as underneath drain pipes, sprinklers, fountains, misters, etc.
- Do not cut, puncture, or penetrate aluminum housing, end caps, or lens covers.
- Do not drop, bang, or rest weight upon luminaire.
- Do not apply excessive pressure to any part of luminaire.
- Do not remove end caps from luminaire.
- Do not bend power cord or continuous connector past permitted bend radius. Bending past permitted bend radius will break the seal of the cordgrip or damage the insulation. (Fig. 6)
- Wet Location: 3.5" minimum bend radius
- Dry Location: 1.5" minimum bend radius
- Do not install in places where the power cord is subject to continuous flexing.
- Do not twist continuous connector or power cord.
- Do not hold, carry, or suspend luminaire by the power cord.
- Do not install on ceilings without mounting clips and set screws. (Fig. 7)

FIGURES

Fig. 1

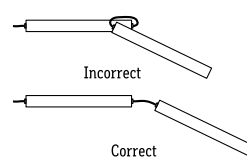

Fig. 2

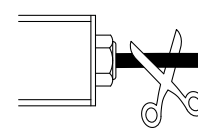

Fig. 3

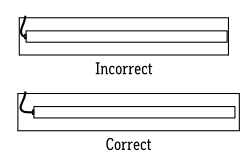

Fig. 4

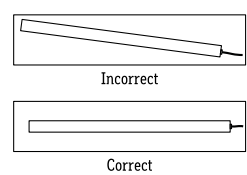

Fig. 5

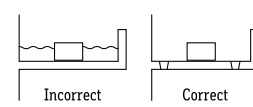

Fig. 6

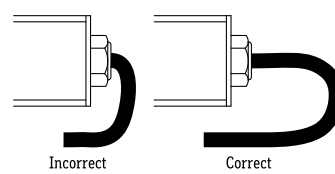
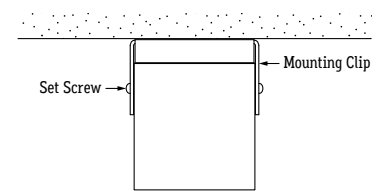

Fig. 7



CLEANING MATERIALS

The use of solvents and/or cleaners which are not compatible with polycarbonate will result in the softening, crazing, and/or cracking of the plastic part. This is especially true of polycarbonate lamps and mounting bases which may be under stress in their normal applications.

COMPATIBLE WITH POLYCARBONATE

- Mild soap and water
- Mineral Spirits
- Isobutyl alcohol
- VM and P Naphtha
- Varsol No.2
- Mexane
- Freone TF and TE-35
- Ethanol
- Dirtex
- 2% Sol. Reg. Joy
- 10% Sol Bon Ami
- White Kerosene
- Methyl alcohol
- Heptane
- Petroleum Ether/65 degrees C
- Isopropyl alcohol
- Lacryl PCL-2035 polycarbonate cleaner

NOT COMPATIBLE WITH POLYCARBONATE

- Trichlor
- Gasoline
- Liquid Detergents
- Acetone
- Carbon Tetrachloride
- Pink Lux (Phosphate free)
- Triclene
- Chlorinated Hydrocarbons
- #1 & #3 denatured alcohol
- Methyl Ethyl Keytone (MEK)
- Texize-8006, 8129, 8758
- MIBK
- Liquid Cleaner – 8211
- Toluol
- Agitene
- Benzol
- Ajax
- Kleenol Plastics
- Lysol
- Stanisol Naphtha
- Oils
- Lemon Joy (phosphate free)
- Diversol
- Lestoil

0-10V DIMMING PROTOCOL

AL-ZYZY is available with a universal 120-277V dimmable integral driver. The driver has 0-10V dimming capabilities from 100% - .1%. Consult factory for other dimming protocols available. The following applies to 0-10V dimming interfaces. A 0-10V fluorescent dimmer will not dim the LEDs.

Technical Requirements For Control Equipment (0-10V Dimming)

- The light output of the LEDs operated by the controllable LED driver is controlled by DC voltage applied to the control input leads (gray and purple). The actual response curve of LED driver current versus control voltage.
- The control device must be capable of accepting or sinking the DC current flow from the driver. The DC current from the driver that must be sunk by the control circuit is approximately 150uA (+/-50% for isolated dim interfaces, up to 1.5mA for non-isolated dim interfaces).
- If the control bus is shorted either by a mechanical switch in the control or by the circuitry of the control device, or inadvertently in the wiring, the current on the control bus will be less than 1.5mA.
- As can be determined from the two items, simple two-level operation of the drivers can be achieved by proper usage and application of a simple open/closed switch on the control bus with maximum light being achieved when the switch is open and minimum light with the switch is closed.
- The driver is intended to be used with control voltages between 0-10V DC volts peak maximum on the driver control leads.
- Control equipment intended to control more than one driver must be capable of sinking the current supplied to the control bus by the maximum number of drivers specified for the control device. At any given level setting it must maintain control bus voltage constant within a range of +/-5% as the number of drivers connected to the control bus varies from a minimum of one driver up to the maximum number specified for the control device.
- Driver of various ratings may be mixed on the same control system.

0-10V DIMMER RATINGS

The stated VA (volt-ampere) rating is the rated capacity of the dimmer which includes the electronic transformer heat losses and the lamp load. A transformer dissipates less than 20% of the connected load as heat. The lamp load plus the transformer loss determine the dimmer capacity required. See the example below.

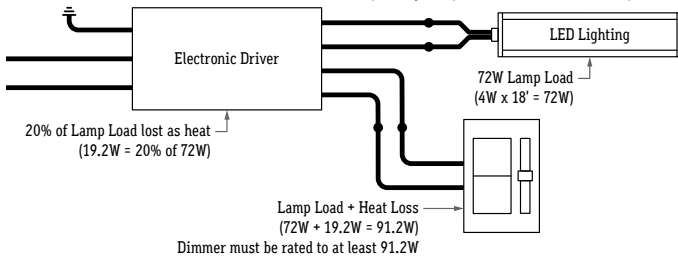

0-10V WIRING DIAGRAM (Power Cord)

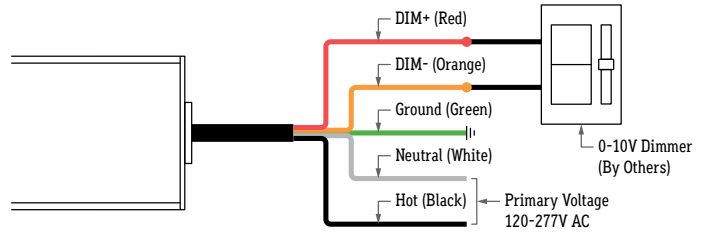

0-10V WIRING DIAGRAM (Conduit)

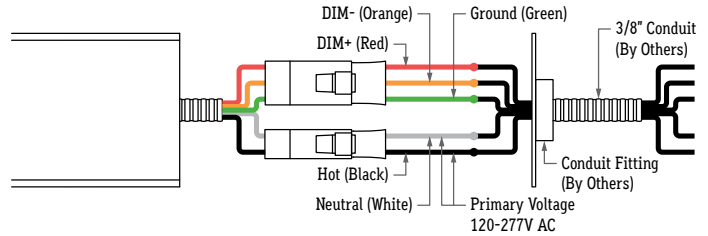

COMPATIBLE 0-10V DIMMERS AND SWITCHES

Manufacturer	Website	Type	Recommended Dimming Curve
Bucsh-Jaegar	www.busch-jaeger.de	2112U-101	Logarithmic
Jung	www.gb.jung.de	240-10	Logarithmic
Leviton Lighting Controls	www.leviton.com	IlumaTech - IP710-DLX	Logarithmic
Lightolier Controls	www.lightolier.com	ZP600FAM120	Logarithmic
Lutron Electronics	www.lutron.com/LEDtool	Nova T - NTFTV, Diva - DVTV, Diva - NFTV	Linear
Merten	www.merten.de	5729	Logarithmic
Pass & Seymour	www.legrand.us	CD4FB-W	Logarithmic
The Watt Stopper	www.wattstopper.com	DCLV1	Logarithmic
Sensor Switch	www.sensorswitch.com	nIO EZ	Linear
Synergy	www.synergylightingcontrols.com	ISD BC	Logarithmic

COMPATIBLE DIMMING CONTROL SYSTEMS

Control Manufacturer	Website	Type	Recommended Dimming Curve
Lutron Electronics	www.lutron.com/LEDtool	Grafik Eye - GRX-TV1 w GRX3503 Energy Savr Node - SQN-4T16-S TVM2 Module	Logarithmic
Crestron	www.crestron.com	GLX-DIMFLV8, GLXP-DIMFLV8, GLPAC-DIMFLV4-*, GLPAC-DIMFLV8-*, GLPP-DIMFLVEX-PM, GLPP-1DIMFLV2EX-PM, GLPP-1DIMFLV3EX-PM, DIN-AO8, DIN-4DIMFLV4, CLS-EXP-DIMFLV, CLCI-1DIMFLV2EX	Logarithmic
ABB	www.abb.com/KNX	SD/S 2.16.1	Logarithmic

LUTRON HI_LUME 2-WIRE DIMMING (LTEA)

Technical Requirements For Control Equipment

- The Hi-Lume 1% 2-Wire LED Driver (LTEA) is a high performance LED driver that provides a smooth, continuous, flicker-free 1% dimming for virtually any LED fixture. Primary voltage is 120V and secondary side is 12VDC or 24VDC. A rated life time of 50,000 hours @tc -149°F (65°C). Inrush current: < 2A. Minimum operating temperature ta = 32°F (0°C).
- Continuous, flicker-free dimming from 100% to 1%. Compatible with selected Maestro Wireless, RadioRA 2, HomeWorks QS, GRAFIK Eye QS, GRAFIK Systems, Quantum, and C-L Dimmers.
- The driver is California Title 24 JA8 Compliant.

Wiring Diagram for Controls Requiring Neutral (JA8 Compliant)

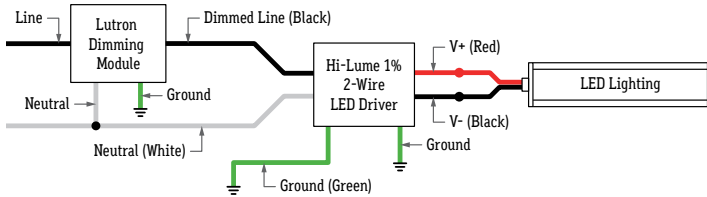

Wiring Diagram for Controls Not Requiring Neutral (JA8 Compliant)

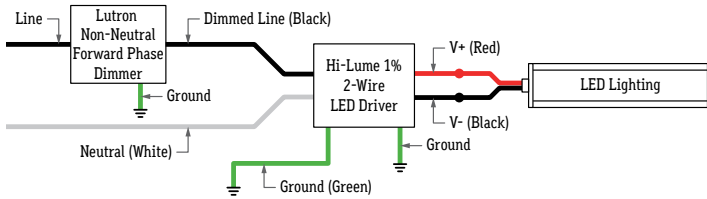

RUNS 8' OR SHORTER

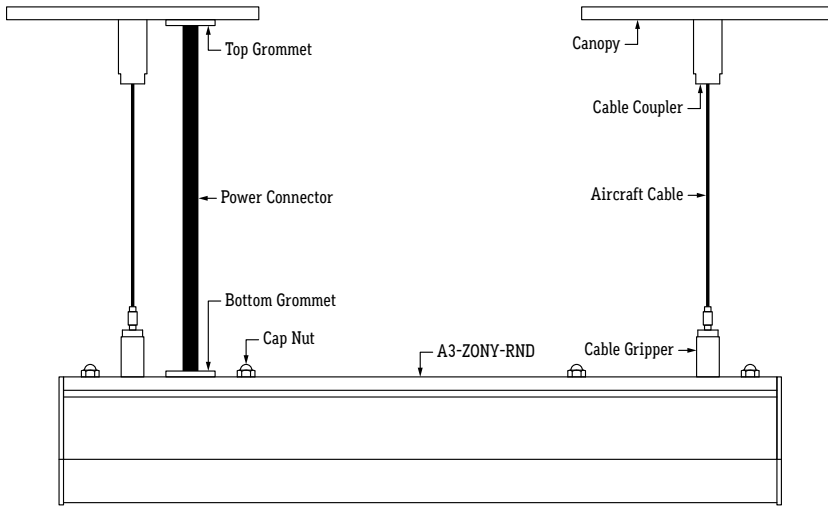

RUNS LONGER THAN 8' (Using A3-ZONY-SQR-SL-CC)

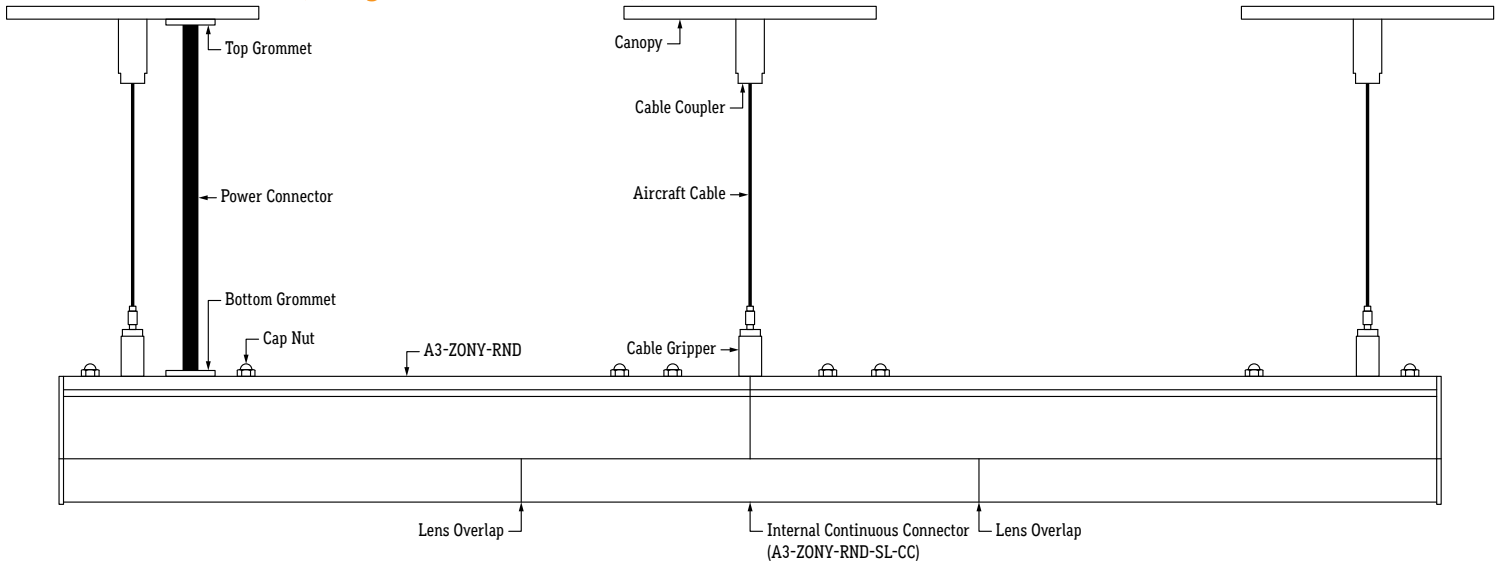

- 1 Arrange luminaire segments in desired pattern.
- 2 Continuous runs are labeled with letters to identify the order of segments in a sequence. If applicable, connect letters in sequence.

Example: A-B-C-D

Lenses are pre-assembled so the seam where two lenses meet is separate from the seam where two extrusions meet. This helps eliminate light leaks and keeps alignment.

Note: Only connect letters in sequence.

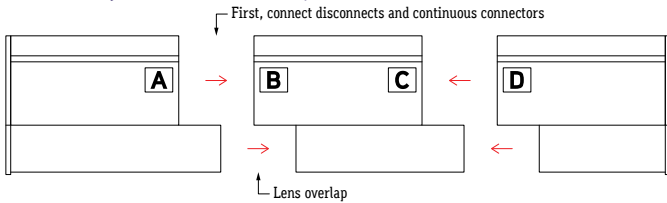

- 3 If applicable, connect disconnects between luminaire segments.

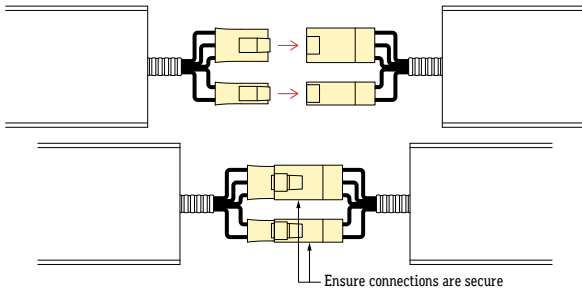

- 4 If applicable, install continuous connector (A3-ZONY-RND-SL-CC). Continue to Step 5 - 7 if using continuous connectors (for runs longer than 8'). If continuous connectors are not being used, continue to Step 8.

- 5 Butt luminaire segments together and slide the segment without a bracket into place.

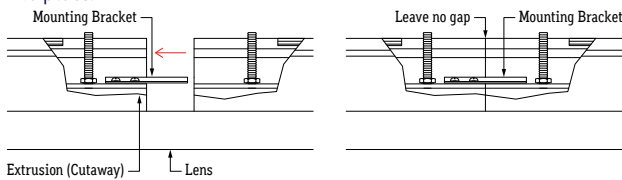

- 6 Ensure bracket holes are aligned to channels within extrusion, then install 4 set screws to secure bracket in place. Luminaires must be held in place by another person while screws are being installed to prevent slipping and misalignment. Screws must be installed in the order described below.

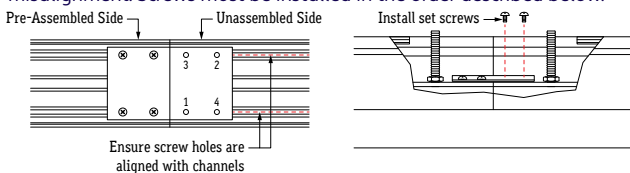

- 7 After bracket is secured, install A3-ZONY-RND-SL-CC to complete connection. Align holes in connector with threaded bolts pre-assembled to luminaire. Snap connector into place, then fasten cap nuts to secure connector.

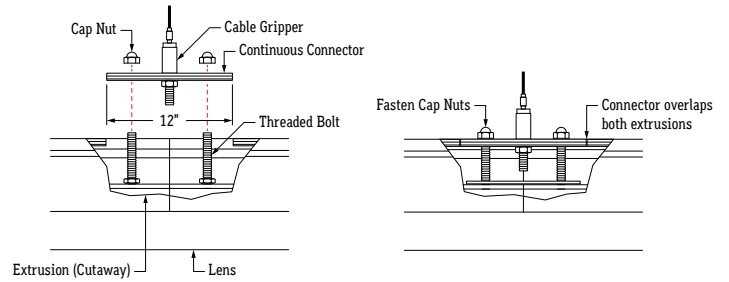

- 8 Mounting Gem Bar to Junction Box (by others).

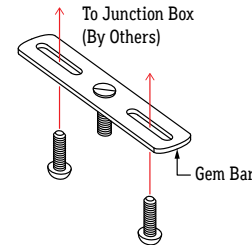

- 9 Make hardwire connections from power connector to Junction Box (by others). **Note:** Refer to Wiring Diagrams for details.

- 10 Perform a continuity test before continuing.

- 11 After wiring connections have been made and continuity test has been completed, place canopy onto Junction Box (by others) and screw cable coupler into place.

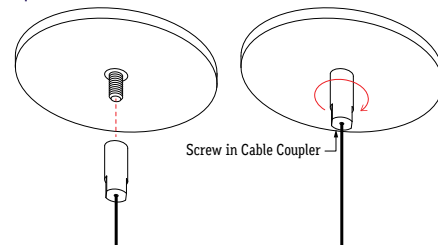

- 12 After all canopies have been securely mounted, gently release luminaire into place. Use a level to ensure each luminaire is not crooked. Adjust cable gripper as needed. **Note:** Do not adjust cable more than 2"

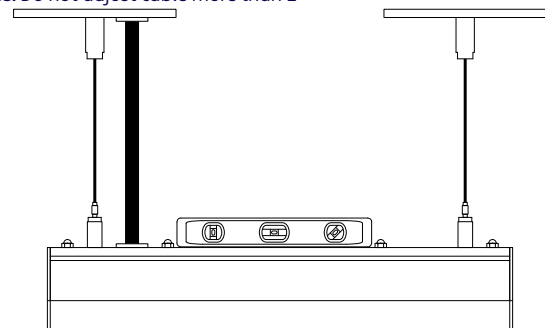

- 1 In the event of a driver failure, the luminaire is easily opened to replace the defective driver.
- 2 Turn off power before beginning. Remove set screws if applicable, then remove luminaire from mounting clips. Turn the segment over and remove bottom cap by using a flathead screwdriver to gently pry the cap away from the housing.

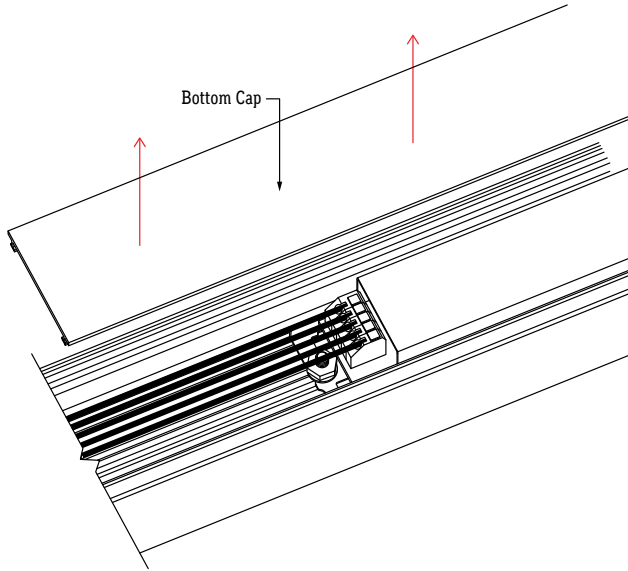

- 4 Loosen hex nut assembly using an 11/32 socket, then slide assembly away from driver to release driver. Do not disassemble the hex nut assembly. Repeat the process on the other end of the driver.

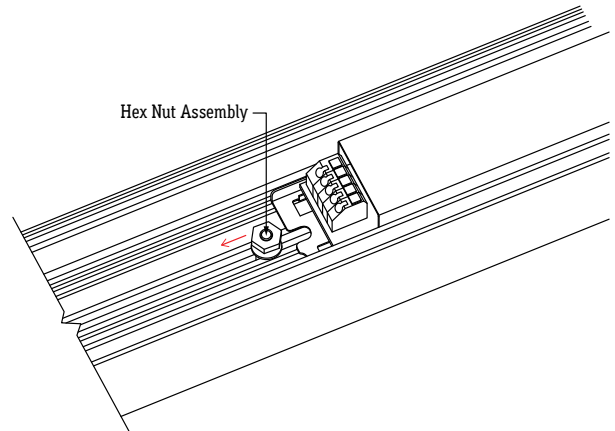

- 3 Push release buttons on terminal block to release wires, then remove wires. Repeat the process on the other end of the driver.
Note: Do not bend, deform, pull, or force wires.
Tip: Take a photo as a reference for the wiring configuration.

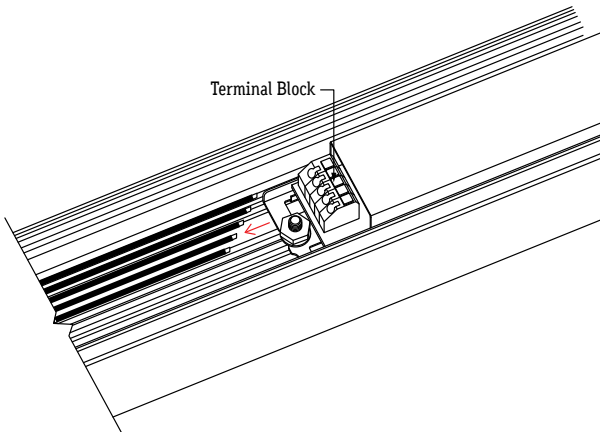

- 5 Remove defective driver from luminaire and replace with a new, identical or similar compatible driver. Mount driver to housing using the hex nut assemblies, then reconnect wires.
Note: Consult factory if uncertain about driver compatibility.

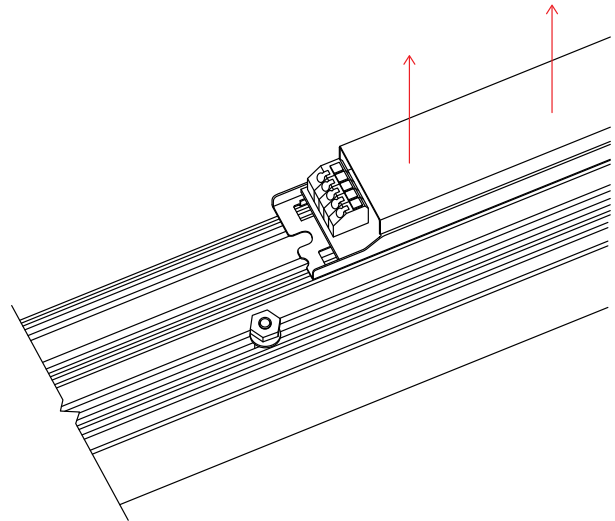

TROUBLESHOOTING TIPS

- Do not reset the breaker multiple times.
- If the unit is overloaded, the breaker will trip, shutting off the driver and lights.
- If the breaker reset button has been held down by hand or any type of pressure, such as duct tape, or if the breaker has been reset multiple times without troubleshooting, the unit will:
 - Burn the driver bobbin.
 - Burn the thermal or magnetic breaker.
 - Burn the driver lead wires due to high amperage caused by overload.
 - Short circuit in line which will not allow the breaker to reset.
 - Damage the lighting.

- 1 Turn off power before beginning. Check for any twisting or damage to the circuit in the LED lightstrip. If there is excessive damage and the circuit is broken, the lightstrip must be replaced.

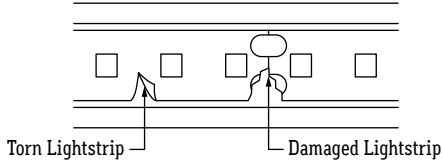

- 2 Check for metal particles or other foreign objects causing the short.

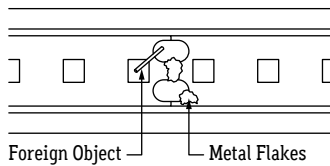

- 3 Check to make sure cuts in the lightstrip are clean and not frayed, causing positive and negative copper pads to touch.

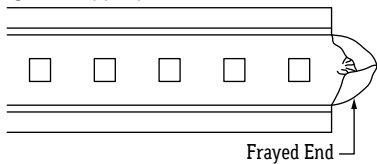

CONTINUITY TEST

A continuity test is performed to determine if electricity can pass through two points on an electrical circuit. This helps identify shorts or malfunctions in the luminaire. Use a multimeter or continuity tester to perform the steps below.

- Always perform a continuity test before connecting to power source.
- Malfunctions are not always as obvious as the lights not turning on.
- A short or malfunction in the line or luminaire will cause damage over time, irreparably damaging the lighting and voiding warranty.

- 1 Turn off power before beginning. Verify power is off by using a non-contact circuit tester (by others). Touch the probe of the tester to the positive wire of the power source. The tester will light up if an electrical current is detected.
- 2 Setup your multimeter tester (by others). First, insert the black probe lead into the COM jack, then insert the red probe lead into the VΩ jack.

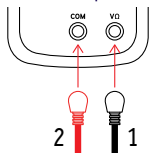

- 3 Measure area where luminaire will be installed. Use a laser line to create a reference line along installation area, ensuring consistent alignment of mounting channels. Mark location where mounting channels will be installed along reference line.

- 4 Touch the red probe to the luminaire extrusion and the black probe to the ground wire (green). If the luminaire is properly grounded, the multimeter will beep, flash, or read 0Ω (ohms). If there is no conductive path, the multimeter will not show any feedback. Troubleshoot to identify the malfunction in the ground wire.

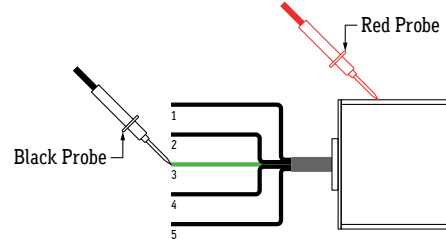

- 5 Touch the red probe to any wire and the black probe to each other wire. Repeat process for each wire. If a conductive path is formed between any of the wires, the multimeter will beep, flash, or read 0Ω (ohms). Troubleshoot to identify the malfunction in the line. If there is no conductive path, the multimeter will not show any feedback.

Example: Check for continuity between Wire 2 and Wire 4

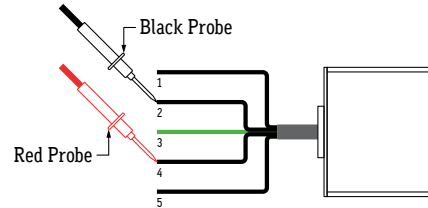

- 6 Touch the red probe to the luminaire housing and the black probe to each wire except ground. If a conductive path is formed between the housing and any of the wires, the multimeter will beep, flash, or read 0Ω (ohms). Troubleshoot to identify the malfunction in the line. If there is no conductive path, the multimeter will not show any feedback.

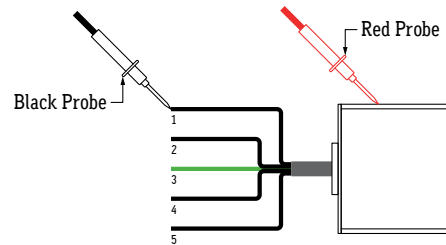

- 7 Set multimeter to AC voltage and test power source. Confirm the correct voltage before connecting luminaire to power source. If the voltage reading is more than 1 volt greater than the marked output voltage, there is a problem with the power source or driver.

- 8 Connect luminaire to power source. If LEDs do not turn on, troubleshoot to find the problem in the line.