

### READ ENTIRE GUIDE BEFORE STARTING INSTALLATION

**Important Notice:** Verify correct luminaire was received with correct color temperature, voltage, and wattage before cutting or installing. ALUZ will not be responsible if incorrect luminaire is installed.

### END VIEWS / DIMENSIONS



### GENERAL FEATURES

<b>Applications</b>	Indoor and Outdoor
<b>Length</b>	Built to Order (+/- 1/8" Tolerance)
<b>Finish</b>	Black
<b>Feed</b>	Standard 6' Power Lead
<b>Strain Relief</b>	Cable (Included, Not for Mounting)
<b>Mounting</b>	Mounting Aircraft Cable (Sold Separately)
<b>Listing</b>	Dry or Wet Location ANSI/UL1598 CSA 22.2 No. 250.0-04, 2nd Edition
<b>UV Rating</b>	Sun Light Resistance
<b>Bug Rating</b>	B0-U0-G0
<b>Dark Sky</b>	Dark Sky Compliant (Only with 24K, 27K, or 30K LEDs)
<b>Installation Link</b>	

### ELECTRICAL

<b>Dimming</b>	Forward Phase
<b>Maximum Run</b>	100'
<b>System</b>	20 Amps (12 Gauge Wire)
<b>Wattage</b>	1W or 3W Lamps (+/- 0.25W Tolerance)
<b>Operating Temperature</b>	-25°C to +45°C (-13°F to +113°F)
<b>Luminaire Voltage</b>	120V

### WEIGHT PER FOOT

Series	Spacing Selection	Approximate Weight
ZOZO Cone Canopy with Cage (A5-ZOZO-COC)	12" on Center (12")	0.62 lbs per foot
	18" on Center (18")	0.45 lbs per foot
	24" on Center (24")	0.37 lbs per foot
	36" on Center (36")	0.28 lbs per foot
	48" on Center (48")	0.24 lbs per foot
	60" on Center (60")	0.22 lbs per foot

### PRODUCT INFORMATION

- For accent, decorative, ambient lighting
- 120VAC system for fast and easy installation
- Long life, energy efficient LEDs
- Can be ordered to specific lengths when exact dimensions are known  
**Example:** 10 x 75'6"
- Plug and light system
- Lead wires are typically 6' long
- UV rated with SunLight resistance
- Outdoor and Indoor rated
- Wire Ratings: 12/2 gauge wire 300V 105° C UL Listed 105° C 300V VW-2 outdoor rated

### ELECTRICAL

- Standard LEDs available in 1W or 3W. See specification submittal for details.
- Maximum Watts per Run is 600W at 120V based on 5 Amps

### INSTALLATION RECOMMENDATIONS

- Determine weight of string light that will be used. Multiply length of string light by weight. Refer to weight per foot table for details.
- An engineer must choose the proper aircraft cable to handle the tension, based on length and weight to prevent product from sagging.
- An engineer must determine the strength of the structure where the cable will attach, based on tension calculation from previous note.
- If installing on a pole, check with pole manufacturer to confirm the pole can handle the tension.
- String light is hung to the aircraft cable using the hooks on each socket. Secure hooks to aircraft cable by crimping or using stainless steel tie wraps.
- The supplied aircraft cable is designed to prevent strain on the wire. An additional aircraft cable is required to hang string lights.

### INSTALLATION TOOLS REQUIRED

- Electric Hammer Drill
- 14.4 to 28 Volt Cordless Drill
- Phillips Bits
- Utility Knife
- Electrical Cord
- Marker
- Wire Stripper
- Long Nose Pliers
- Drill Bits - Concrete or Wood
- Electrical Three Ways
- Safety Glasses
- Measuring Tape
- Laser Line or Chalk Line

### WARNING

When using ZOZO for any application, basic safety precautions should always be followed to reduce the risk of fire, electric shock, and personal injuries. Lighting must be installed in accordance with the NEC or CEC as applicable. ALUZ will not be responsible for any damage or malfunction caused by the following:

- Do not connect string light to power source while spooled or coiled. (Fig. 1)
- Maintain at least one half inch spacing between parts when lit.
- Surge protector must be set up for electrical power system to avoid damaging string light.
- Ground Fault Circuit Interrupter (GFCI) protection is required on circuits or outlets when string light is used for outdoor applications.
- Do not suspend string light from strain relief cable. (Fig. 2)
- Do not secure string light with staples, nails, or like means that might damage the insulation. Secure by using mounting aircraft hook.
- Do not install string light where it is subject to continuous flexing.
- Do not route string light through walls, doors, windows, or building structures.
- Do not cover string light, the covering may cause it to overheat, melt, or ignite.
- Do not mount string light inside cabinets, tanks, or enclosures of any kind without proper ventilation.
- Do not run string light at an operation temperature below -40°C (-40°F) or above 55°C (131°F).
- Do not install dry location product outdoors. (Fig. 3)
- Do not mount string light where bulbs or sockets will be subjected to pooling water. (Fig. 4)
- Do not submerge string light in liquid or install near standing water or other liquids.
- Do not penetrate bulbs or wires with any foreign object. (Fig. 5)
- Do not cover bulbs or sockets with any material. (Fig. 6)
- Do not overlap bulbs at any location. (Fig. 7)
- Do not apply excessive pressure to bulbs. (Fig. 8)
- Do not use string light if damaged, such as, broken outer jacket, loose connections, or frayed wire insulation. Inspect periodically to ensure there is no damage.
- Do not roll out string light on rough surfaces or over sharp corners.
- Do not bend light string to a diameter of less than 1.5". (Fig. 9)
- Do not bend wire along horizontal plane or allow sockets to touch. Leave minimum 1.5" gap between sockets. (Fig. 10)
- Do not fold, crease, or twist light string. (Fig. 11)
- Do not wrap excess wire around bulbs or sockets. (Fig. 12)

### FIGURES

Fig. 1

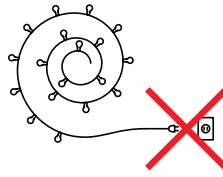

Fig. 2

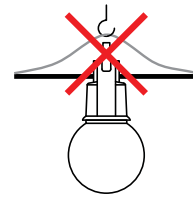

Fig. 3



Fig. 4

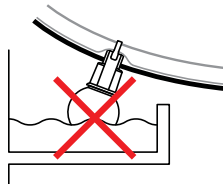

Fig. 5

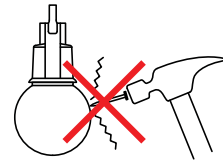

Fig. 6

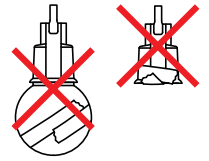

Fig. 7

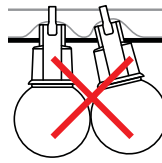

Fig. 8

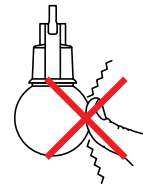

Fig. 9

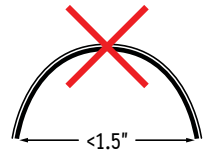

Fig. 10

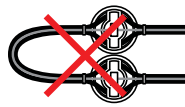

Fig. 11

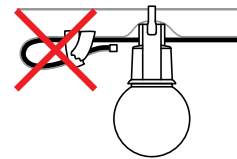
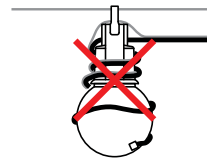

Fig. 12



Note: Canopies not pictured

### CLEANING MATERIALS

The use of solvents and/or cleaners which are not compatible with polycarbonate will result in the softening, crazing, and/or cracking of the plastic part. This is especially true of polycarbonate lamps and mounting bases which may be under stress in their normal applications.

### COMPATIBLE WITH POLYCARBONATE

- Mild soap and water
- Mineral Spirits
- Isobutyl Alcohol
- VM and P Naphtha
- Varsol No.2
- Mexane
- Freone TF and TE-35
- Ethanol
- Dirtex
- 2% Sol. Reg. Joy
- 10% Sol Bon Ami
- White Kerosene
- Methyl Alcohol
- Heptane
- Petroleum Ether/65 degrees C
- Isopropyl Alcohol
- Lacryl PCL-2035
- Polycarbonate Cleaner

### NOT COMPATIBLE WITH POLYCARBONATE

- Trichlor
- Gasoline
- Liquid Detergents
- Acetone
- Carbon Tetrachloride
- Pink Lux (Phosphate free)
- Triclene
- Chlorinated Hydrocarbons
- #1 & #3 Denatured Alcohol
- Methyl Ethyl Keytone (MEK)
- Texize-8006, 8129, 8758
- MIBK
- Liquid Cleaner - 8211
- Toluol
- Agitene
- Benzol
- Ajax
- Kleenol Plastics
- Lysol
- Stanisol Naphtha
- Oils
- Lemon Joy (Phosphate Free)
- Diversol
- Lestoil

**Note:** Canopies not pictured

### SINGLE RUN (TOP VIEW)

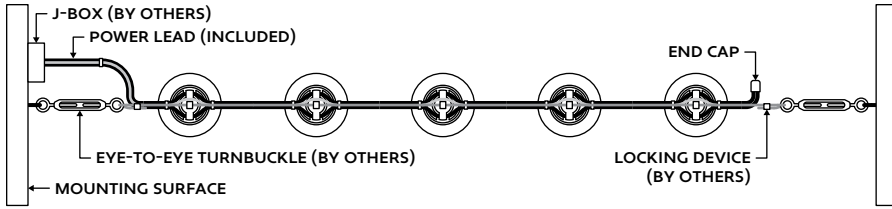

### SINGLE RUN (SIDE VIEW)

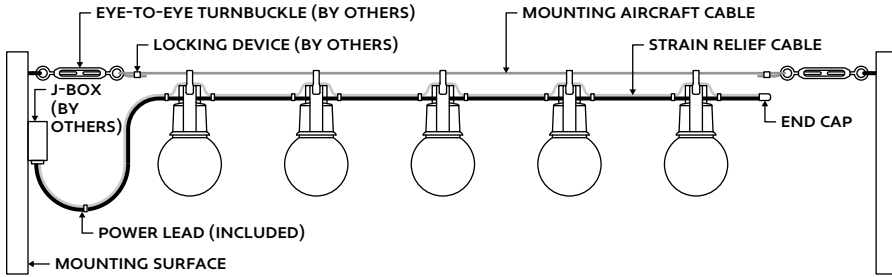

### ZIG-ZAG RUN (TOP VIEW)

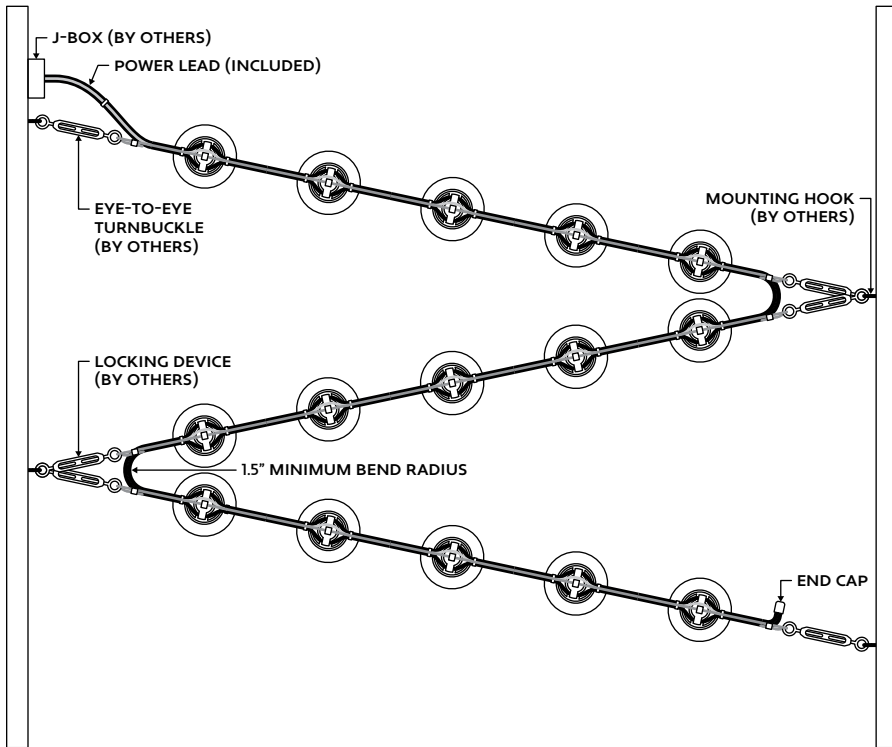

### NOTE

- Below are acceptable ways to mount the Mounting Aircraft Cable (A5-ZOZO-AC-18)
- Size of hooks, bolts, clamps, and other hardware to be determined by installer.  
The mounting cable is 1/8" in diameter.
- Always confirm hardware is rated for the weight of the string light.

### POLE MOUNTING (Hook Bolt)

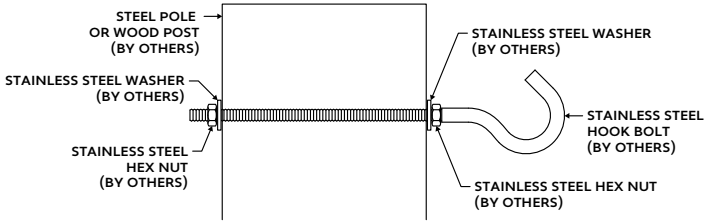

### POLE MOUNTING (Eye Bolt)

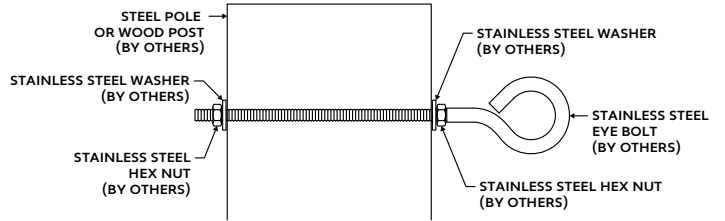

### CABLE CRIMPING (Wire Rope Clamps)

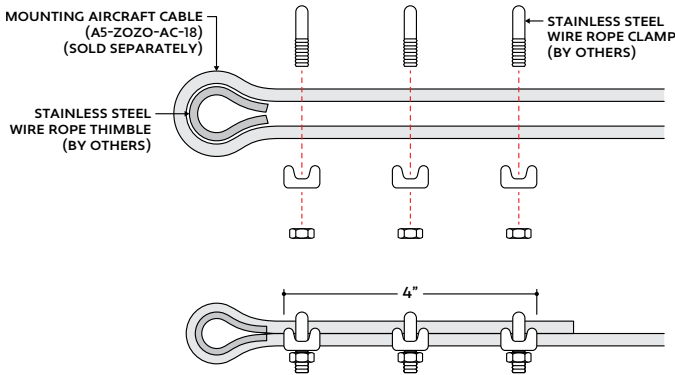

### CABLE CRIMPING (Cable Ferrules)

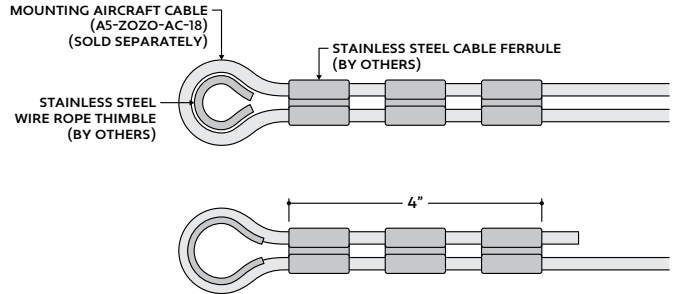

### DIAGRAM OF ASSEMBLY (Pole with Eye Hook, Turnbuckle, and Wire Rope Clamps)

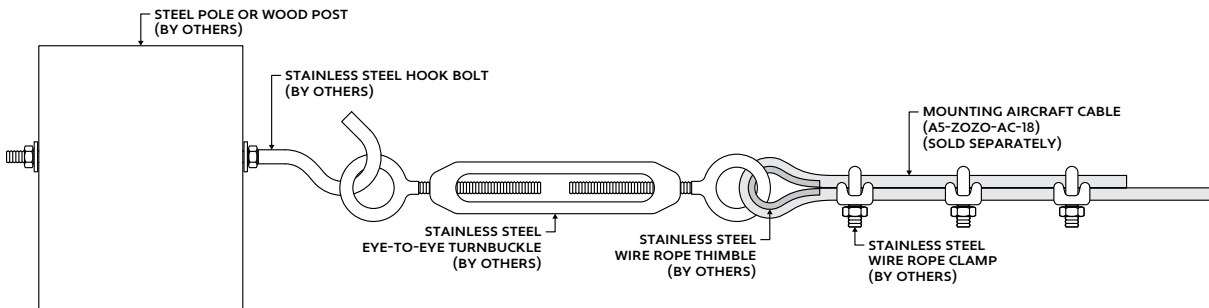

**Note:** Canopies not pictured

### APPLICATION GUIDELINES

- Follow the below diagrams and steps if applicable to your installation.
- String lights require a team effort to ensure a secure and correct installation.
- Use a wire puller stand to prevent tangles, twists, and snags when installing.

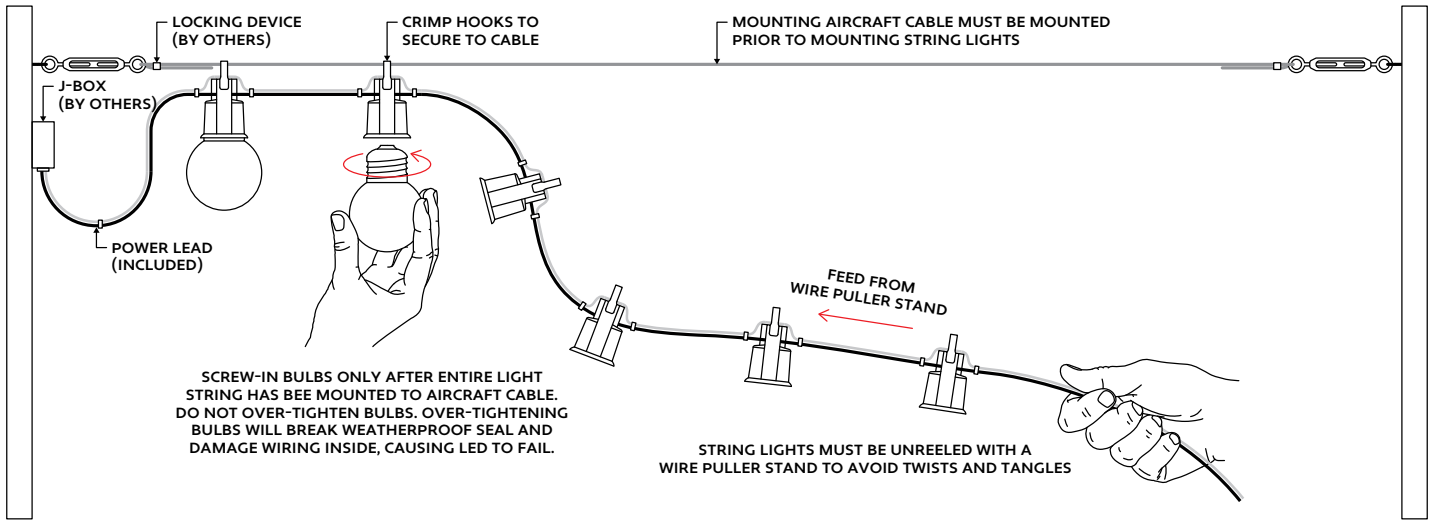

### WET LOCATION LAMP GASKETS

- A Lamp Gasket (A5-ZOZO-GS) must be used on each lamp for wet location applications.
- First, place the lamp gasket onto lamp threads. The align the bottom edge of the gasket with the lip of the threads where it meets the glass. Do not place gasket over the glass.

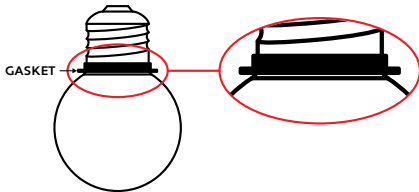

- Screw lamp into socket. The long edge of the gasket should sit flush with the rim of the socket.

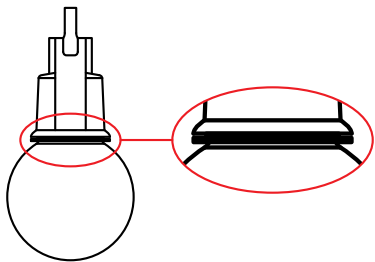

- 1 Measure area where light string will be installed. Install screw-in mounting hooks (by others) at desired locations. Ensure hooks are rated for the weight of your light string and hooks are facing upwards when mounted.  
**Note:** Refer to Mounting Details for additional information about mounting hardware.

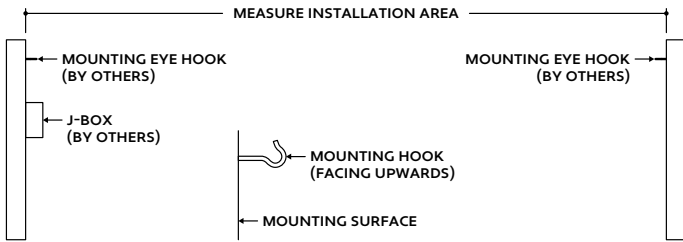

- 2 Attach eye-to-eye turnbuckles (by others) at each mounting hook, then loop Mounting Aircraft Cable through turnbuckle eye and secure with wire rope clamp (by others) or cable ferrule (by others). Ensure all accessories are rated for the weight of your light string.

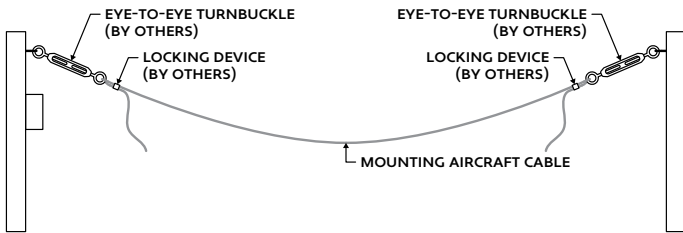

- 3 Tighten turnbuckles to achieve desired tension, then trim Mounting Aircraft Cable slack, leaving at least 3" of cable slack past the locking device.

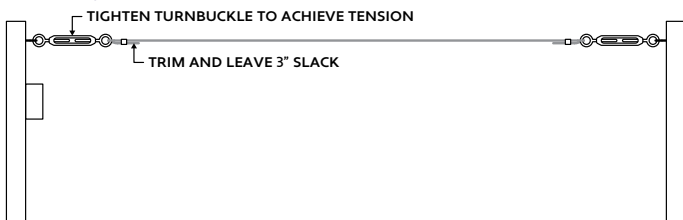

- 4 Hang sockets onto Mounting Aircraft Cable using Mounting Aircraft Hooks. Position light string to desired location, then use pliers to crimp each mounting hook to hold in place.

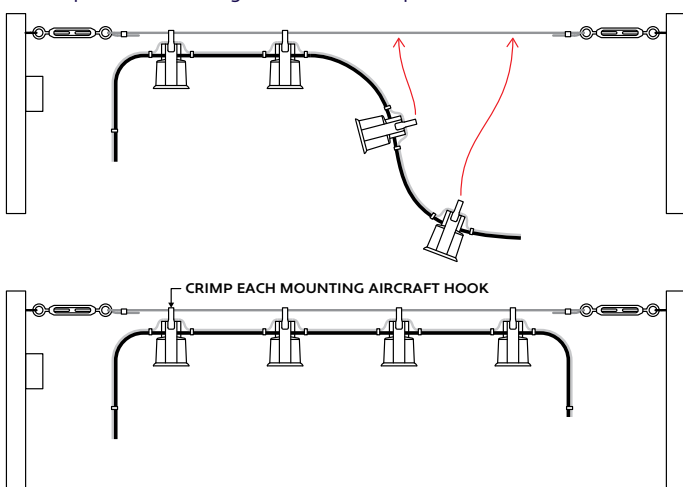

- 5 Install bulbs to light string by screwing bulbs into socket. Do not over-tighten bulbs. Over-tightening bulbs will damage internal components, compromising weather seals.  
**Note:** A small amount of the screw threads will show between socket and bulb. Do not attempt to screw bulb beyond this point.

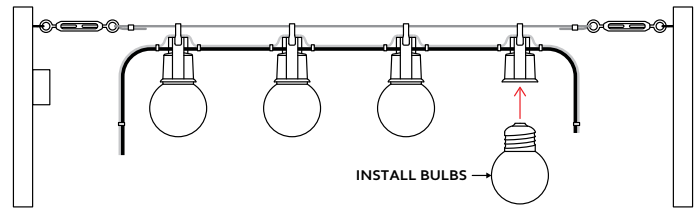

- 6 Perform a continuity test before continuing. Refer to Continuity Test page for details.

- 7 Trim excess tail and install End Cap to end of run. Use sharp cutters to cut tail wires and Strain Relief Cable simultaneously. Ensure wires and cable are not touching. Apply a generous amount of silicone to inside of End Cap, then fully insert wires and cable. Allow silicone to seep out around edges of End Cap for a proper seal. Check the seal for holes or gaps.

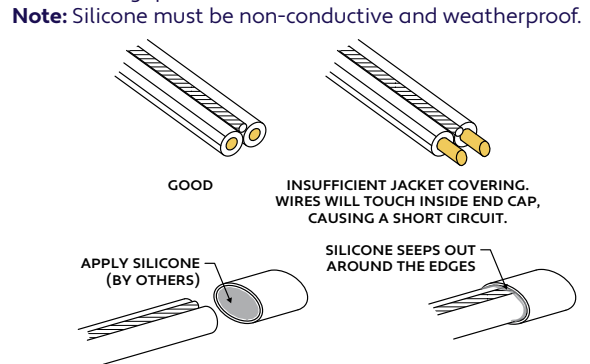

- 8 Connect light string to power source. Refer to Power Plug steps or Hardwire steps, depending on your application.

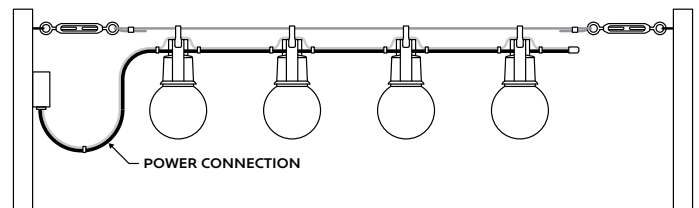

- 1 Measure area where string light will be installed. Install screw-in mounting eye hooks at desired locations. Ensure hooks are rated for the weight of your string light.  
**Note:** Refer to Mounting Details for additional information about mounting hardware.

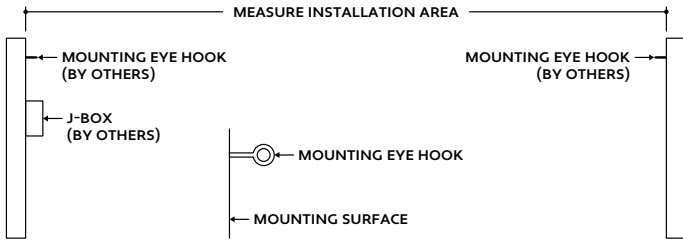

- 2 Loop cable through Cable Lock and mounting eye hook.

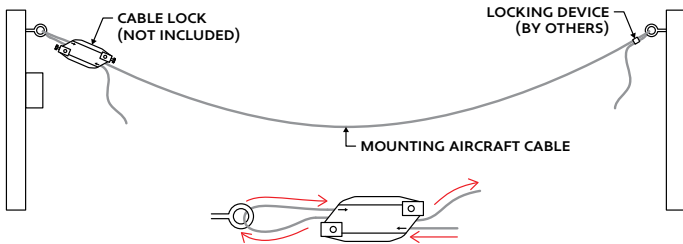

- 3 Use a cable tensioner (sold separately) to create tension along the cable, then install locking pins.

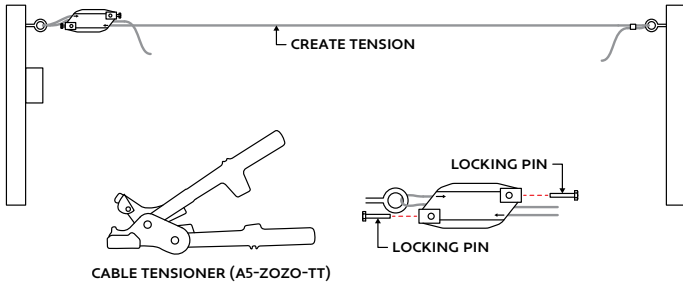

- 4 Hang sockets onto Mounting Aircraft Cable using Mounting Aircraft Hooks. Position string light to desired location, then use pliers to crimp each mounting hook to hold in place.

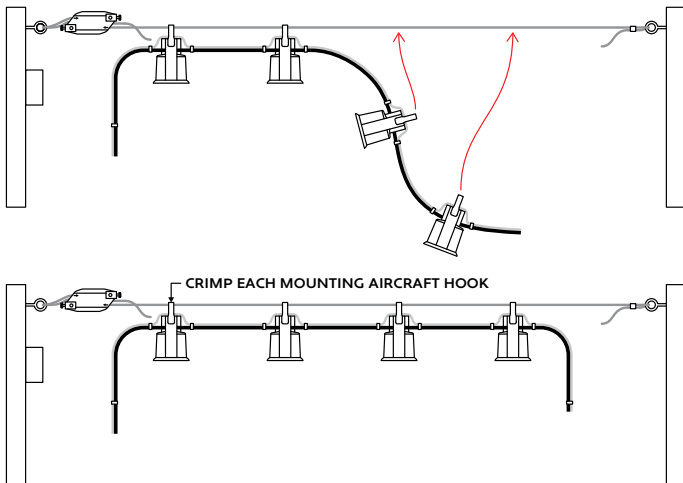

- 5 Install bulbs to string light by screwing bulbs into socket. Do not over-tighten bulbs. Over-tightening bulbs will damage internal components, compromising weather seals.  
**Note:** A small amount of the screw threads will show between socket and bulb. Do not attempt to screw bulb beyond this point.

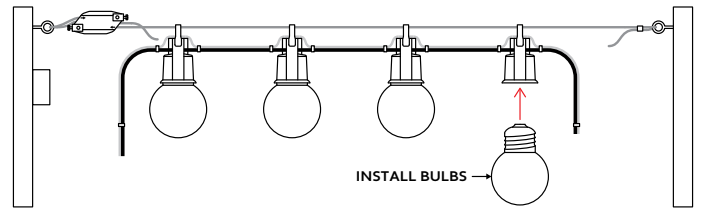

- 6 Perform a continuity test before continuing. Refer to Continuity Test page for details.

- 7 Trim excess tail and install End Cap to end of run. Use sharp cutters to cut tail wires and Strain Relief Cable simultaneously. Ensure wires and cable are not touching. Apply a generous amount of silicone to inside of End Cap, then fully insert wires and cable. Allow silicone to seep out around edges of End Cap for a proper seal. Check the seal for holes or gaps.  
**Note:** Silicone must be non-conductive and weatherproof.

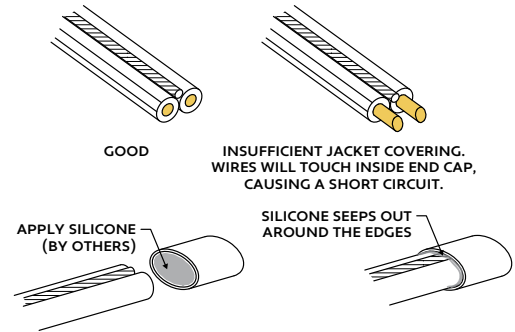

- 8 After load is suspended, use the cable tensioner (sold separately) to eliminate any undesired slack in the cable. Set both locking pins on each Cable Lock, then trim excess cable and leave a minimum of 3" of slack.

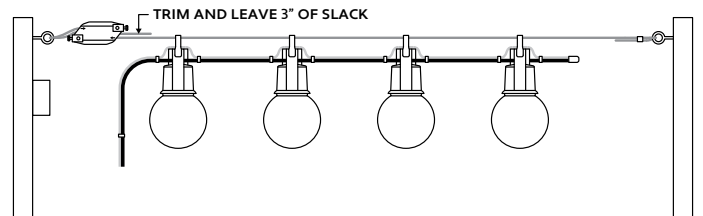

- 9 Connect string light to power source. Refer to Power Plug steps or Hardwire steps, depending on your application.

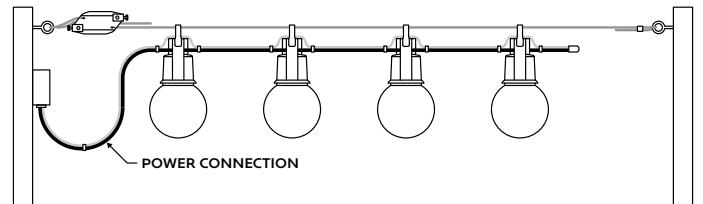



- Measure area where light string will be installed. Install Mounting Plates at desired locations.  
**Note:** Ensure mounting surface is appropriate and capable of supporting the weight of the light string. Refer to Mounting Details for additional information about mounting hardware.

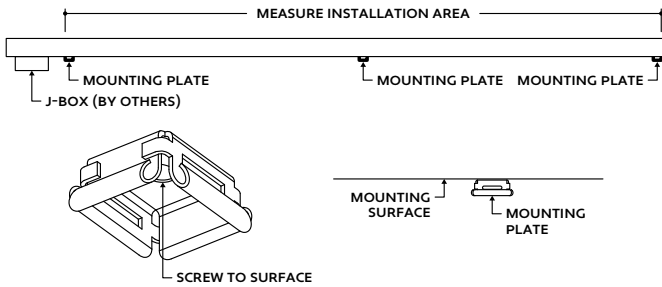

- Attach stainless steel cable tie (by others) to each mounting plate. Feed cable tie through Mounting Plate eyelets to create a loop. Secure cable ties and trim excess.

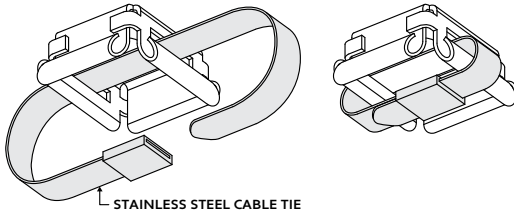

- Feed Mounting Aircraft Cable through the first Mounting Plate loop and secure with wire rope clamps (by others) or cable ferrules (by others). Ensure all accessories are rated for the weight of the light string.

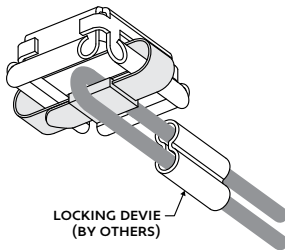

- Feed Mounting Aircraft Cable through the second Mounting Plate loop, then the third, and secure with wire rope clamp (by others) or cable ferrule (by others) in the same fashion as the first Mounting Plate loop.

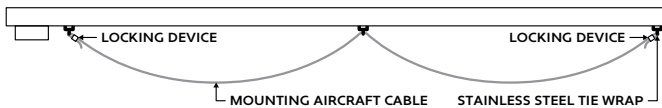

- Hang sockets onto Mounting Aircraft Cable using Mounting Aircraft Hooks. Position light string to desired location, then use pliers to crimp each mounting hook to hold in place.

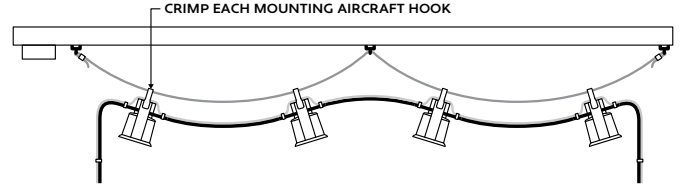
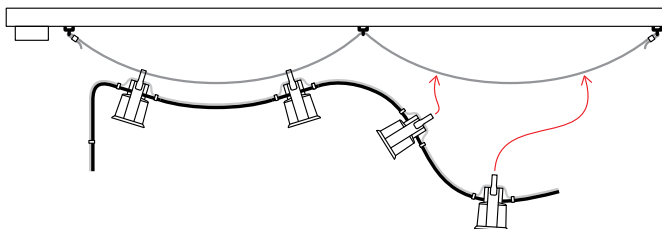

- Install bulbs to light string by screwing bulbs into socket. Do not over-tighten bulbs. Over-tightening bulbs will damage internal components, compromising weather seals.  
**Note:** A small amount of the screw threads will show between socket and bulb. Do not attempt to screw bulb beyond this point.

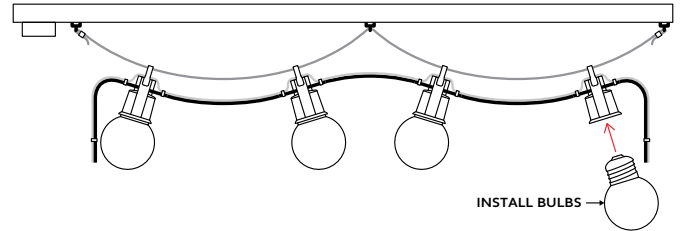

- Perform a continuity test before continuing. Refer to Continuity Test page for details.

- Trim excess tail and install End Cap to end of run. Use sharp cutters to cut tail wires and Strain Relief Cable simultaneously. Ensure wires and cable are not touching. Apply a generous amount of silicone to inside of End Cap, then fully insert wires and cable. Allow silicone to seep out around edges of End Cap for a proper seal. Check the seal for holes or gaps.  
**Note:** Silicone must be non-conductive and weatherproof.

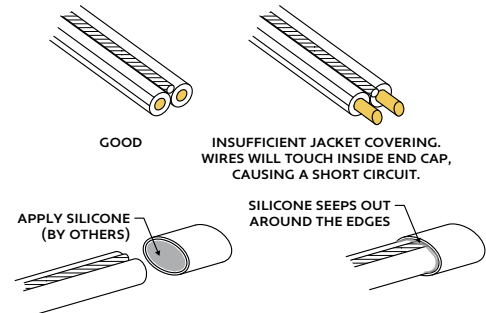

- Connect light string to power source. Refer to Power Plug steps or Hardwire steps, depending on your application.

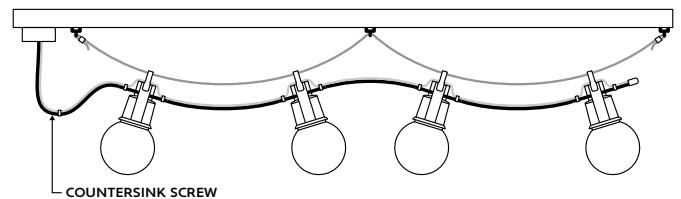



- 1 Use sharp cutters to cut lead wires to desired length.

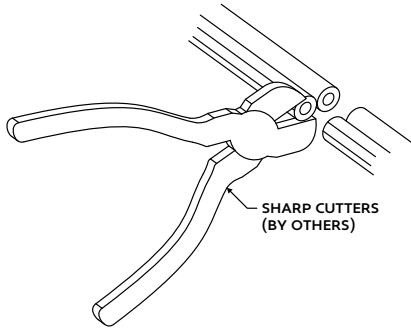

- 2 Separate wires and strip 1/4" to expose conductor wires. The hot wire has ridges on the jacket and the neutral wire has a smooth jacket.

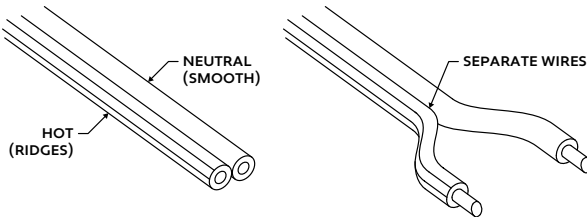

- 3 Open Power Plug to access screw terminals inside.

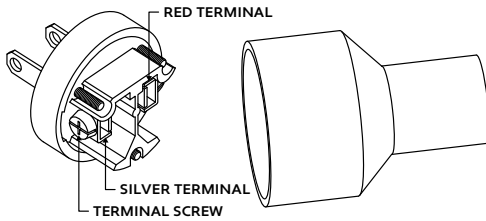

- 4 Connect the neutral wire to the silver screw terminal and connect the hot wire to brass screw terminal.

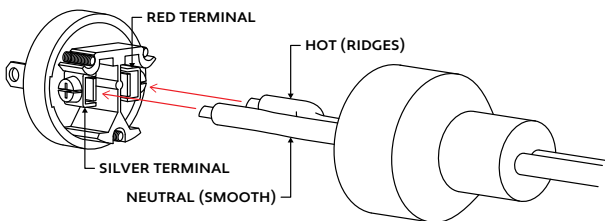

- 5 Ensure wires are secured in screw terminals, then reassemble Power Plug.

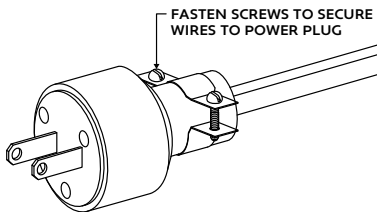

- 6 Perform continuity test before continuing. Refer to Continuity Test page for details.

- 7a Connect power plug to GFCI power source (Dry Location Only). **Note:** For Power Plug applications, the Strain Relief Cable must be grounded.

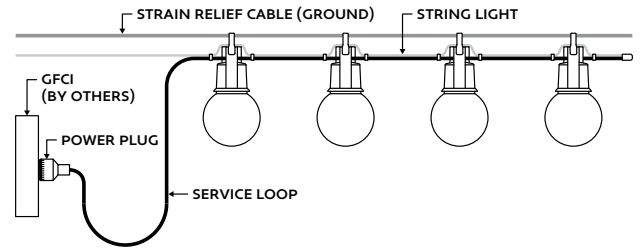

- 7b Connect Power Plug to GFCI power source. Use weatherproof outlet protector (by others) for wet location products. **Note:** For Power Plug applications, the Strain Relief Cable must be grounded.

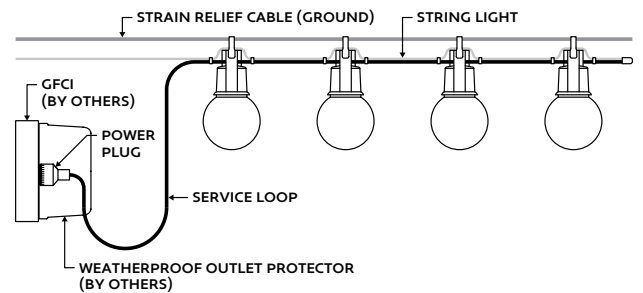

- 7c Refer to the below diagram for details on grounding the strain relief cable.

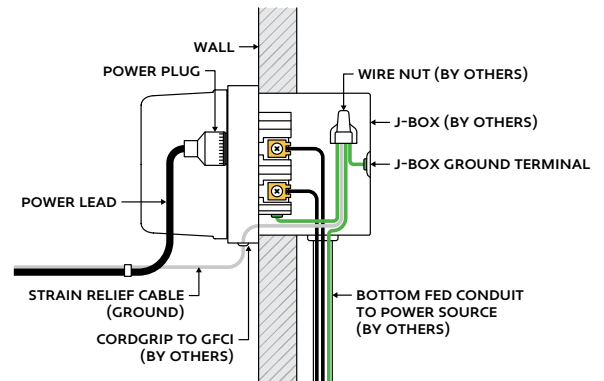

### HARDWIRING OVERVIEW

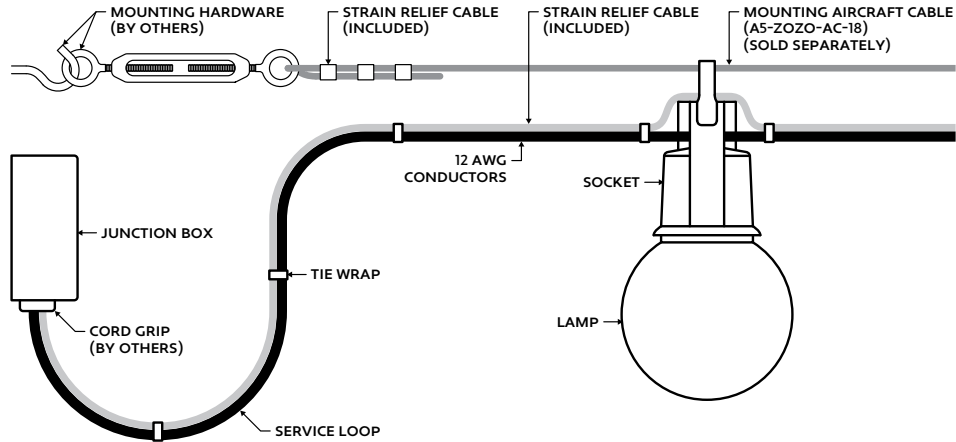

- Feed conductors and Strain Relief Cable into junction box and secure with a cord grip or strain relief fitting. The Strain Relief Cable must be grounded inside the junction box.
  - Leave enough excess wire to create a relaxed service loop going into the junction box.
- Note:** For outdoor applications, junction box (by others) and cord grip (by others) must be outdoor rated.

### WIRING DIAGRAM

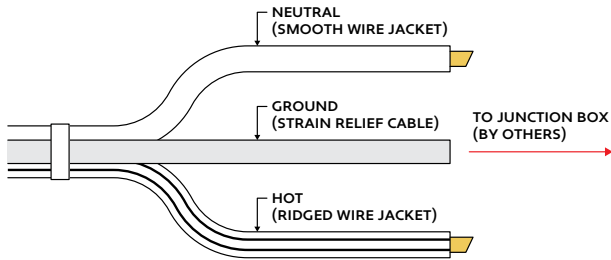

### WIRE DIMENSIONS

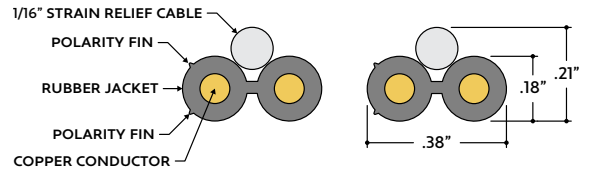

### TROUBLESHOOTING TIPS

- Do not reset the breaker multiple times
- If the unit is overloaded, the breaker will trip, shutting off the lights
- If the breaker reset button has been held down by hand or any type of pressure, such as duct tape, or if the breaker has been reset multiple times without troubleshooting, the unit will:
  - Burn the thermal or magnetic breaker
  - Burn the primary wires due to high amperage caused by overload
  - Short circuit in line which will not allow the breaker to reset
  - Damage the lighting

- 1 Turn power off before beginning. Check for any twisting or damage to the wires of the light string.

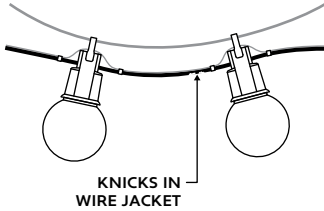

- 2 Check end cap for metal particles or other debris that could cause a short.

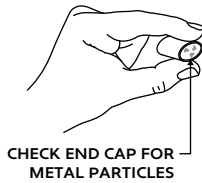

- 3 Check to ensure wire cuts are clean & sealed with not fraying, causing hot and neutral wires to touch.

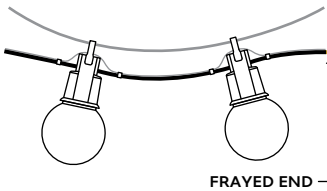

- 4 Ensure the lead wires are not too long and dangling, wound, or coiled.

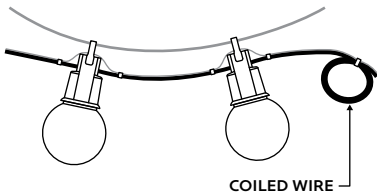

- 5 Ensure there are no missing or broken bulbs along light string.

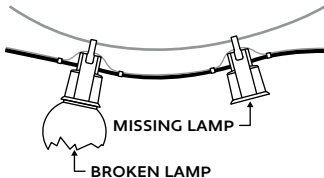

### CONTINUITY TEST

A continuity test is performed to determine if electricity can pass through two points on an electrical circuit. This helps identify shorts or malfunctions in the line or fixture. Use a multimeter or continuity tester to perform the steps below.

- Always perform a continuity test before connecting lighting to power source.
- Malfunctions are not always as obvious as the lights not turning on.
- A short or malfunction in the line or fixture will cause damage over time, ultimately damaging the lighting and voiding warranty.

- 1 Turn power off before beginning. Verify power is turned off by using a non-contact circuit tester. Touch the probe of the tester to positive wire of the power source. The tester will light up if an electrical current is detected.
- 2 Setup your tester. First insert the black probe lead into the COM jack, then insert the red probe lead into the VΩ jack.
- 3 Verify that your tester is functional by touching probes together. The tester should light up, beep, or read 0Ω (ohms) of resistance.
- 4 Touch the red probe to the hot wire and the black probe to the strain relief cable. If a conductive path is found between them, the multimeter will beep, flash, or read 0Ω (ohms). Troubleshoot to identify the malfunction in the line. If there is no conductive path, the multimeter will not show any feedback.

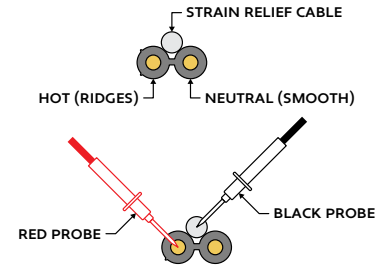

- 5 Touch the red probe to the hot wire and the black probe to the neutral wire. If a conductive path is found between them, the multimeter will beep, flash, or read 0Ω (ohms). Troubleshoot to identify the malfunction in the line. If there is no conductive path, the multimeter will not show any feedback.

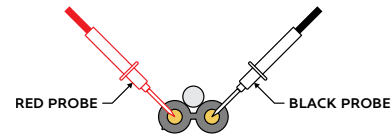

- 6 Touch the red probe to the neutral wire and the black probe to the strain relief cable. If a conductive path is found between them, the multimeter will beep, flash, or read 0Ω (ohms). Troubleshoot to identify the malfunction in the line. If there is no conductive path, the multimeter will not show any feedback.

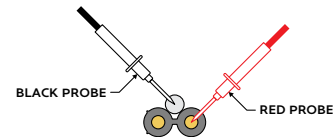

- 7 Set voltmeter to AC voltage and test power source. Confirm the correct voltage before connecting lighting to power source. If voltage reading is more than 1 volt higher than the marked output voltage, there is a problem with the power source or driver.
- 8 Connect power connector to power source. If LEDs do not turn on, troubleshoot to find the problem in the line.

- 1 Remove bulb from socket. Cut both zip ties around damaged socket and move strain relief cable aside. Break silicone seal on damaged socket.  
**Note:** Be mindful not to damage the conductor wires when cutting ties and removing silicone.

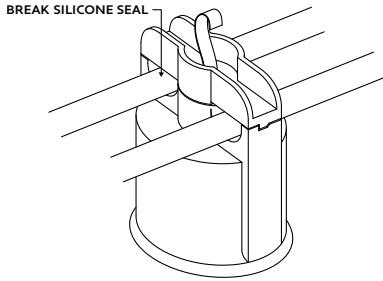

- 2 After silicone seal is broken, twist top portion of socket counterclockwise and release socket from conductor wires. Remove canopy from socket if present.

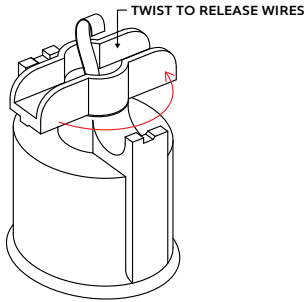

- 3 If applicable, install canopy onto replacement socket.

- 4 Examine the underside of the conductor wires where damaged socket was removed. Align the punctures from the old socket with the contacts of the new socket. Position the conductor wires on the contacts of the new socket. Place the wire with lettering onto the silver colored contact. Place the wire without lettering onto the brass colored contact. Use the shank of a screwdriver or similar means to press each wire all the way into the contacts, then twist top portion of socket clockwise until it snaps and locks into place.

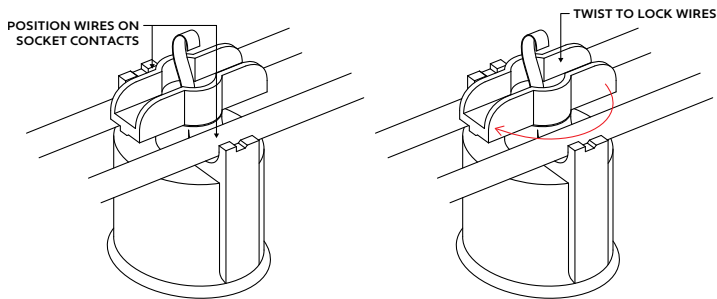

- 5 Apply silicone to seal all openings between the top and bottom portions of the socket. Ensure all openings are covered with silicone and securely sealed.

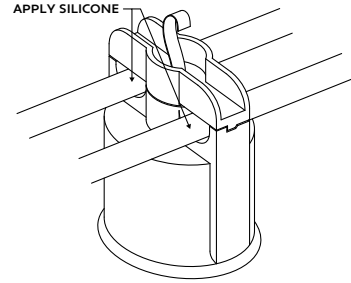

- 6 Install zip ties around conductor wires and strain relief cable to prevent wires from separating.

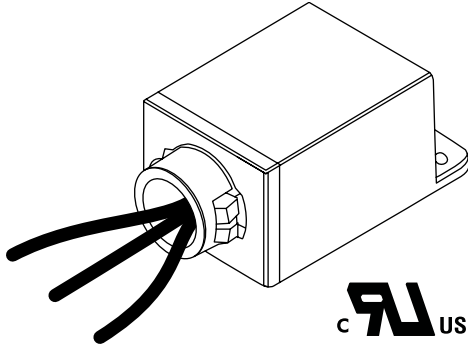

### CASE DIMENSIONS

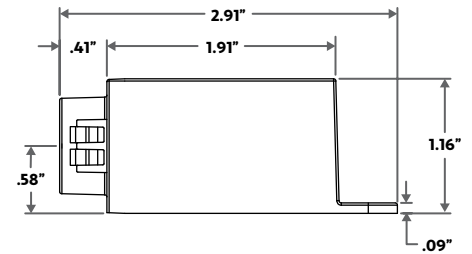
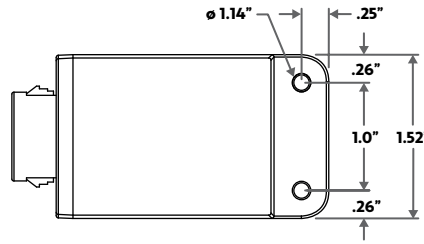

### SURGE PROTECTOR SPECIFICATIONS

Model	Input Voltage	Surge Protection Level	Mounting	Enclosure Material	Input Needs	Input Frequency
ALS-P	120V - 277V	0kV, 10kA, ANSI C62.41 Category C	SnapLOCK / Footed	Polycarbonate	6", 18AWG stranded, 105°C stripped, 3/8" tinned	60Hz

### PRODUCT FEATURES

The Surge Series are 3-leaded devices that protect Line-Ground, Line-Neutral, and Neutral-Ground in accordance with IEEE / ANSI C62.41.2 guidelines. Protects against surges according to IEEE C62.41.2 C High (10kA and 10kV). Surge current rating = 10,000 Amps using industry standard 8/20 Sec wave. Surge Location Rated Category C3. UL Recognized Component in the United States and Canada (UL1449). Type 4 Surge Protection Device. High temperature, flame retardant plastic enclosure, 85°C maximum surface temperature rating. Thermally Protected Transient Over-voltage Circuit.

### PRODUCT SPECIFICATIONS

The Surge series of products are designed to be used in conjunction with LED Drivers and fixtures to provide an additional level of protection against powerline disturbances in industrial, commercial and residential applications where surge protection to IEEE C62.41.2 is required.

### 120V WIRING DIAGRAM (FORWARD PHASE DIMMING)

