

### READ ENTIRE GUIDE BEFORE STARTING INSTALLATION

**Important Notice:** Verify correct luminaire was received with correct color temperature, voltage, and wattage before cutting or installing. ALUZ will not be responsible if incorrect luminaire is installed.

### END VIEW / DIMENSIONS

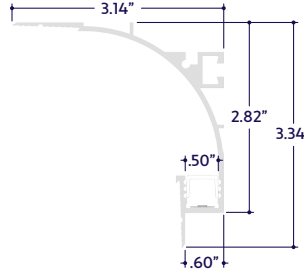

### GENERAL FEATURES

<b>Applications</b>	Mud-In, Accent, Decorative, Surface, Recessed Lighting
<b>Lens</b>	50% Semi-Frosted or 100% Frosted
<b>Viewing Angle</b>	120°
<b>Length</b>	Built to Order (+/- 1/8" Tolerance)
<b>Construction</b>	Aluminum Extrusion
<b>Weight</b>	0.80 lbs per foot
<b>Mounting</b>	Mud-In
<b>Listing</b>	Dry or Damp Location UL2108, CSA C22.2 #9 UL8750, CSA250
<b>Driver</b>	Remote (Sold Separately)
<b>Temperature Ratings</b>	Operating / Startup: -20° to 48°C (-4° to 120°F) Storage: -40° to 76°C (-40° to 170°F)
<b>Installation Link</b>	

### ELECTRICAL

<b>Dimming</b>	0-10V, Forward / Reverse Phase, Lutron, DMX, DALI
<b>Maximum Run (Class 1 Applications)</b>	18' (6.5W), 21' (5.5W), 26' (4.5W), 33' (3.6W), 36' (1.5W, 2.5W)
<b>Maximum Run (Class 2 Applications)</b>	14' (6.5W), 17' (5.5W), 21' (4.5W), 26' (3.6W), 36' (1.5W, 2.5W)
<b>Luminaire Voltage</b>	24VDC

### PRODUCT INFORMATION

- For accent, decorative, surface, recessed, or pendant lighting
- 24 Volts DC for easy and safe installation
- Long life, energy efficient LEDs
- Can be ordered to specific lengths for when exact dimensions are known  
**Example:** 10 x 10'6"
- Plug and light system
- Lead wires are typically 36" long and exit on one end

### ELECTRICAL REQUIREMENTS

- Luminaires require a 24 Volt DC remote driver.
- To calculate driver size, determine Watts per Foot.  
**Example:** 1.5W per Foot
- Determine Length in Feet.  
**Example:** 30'
- Calculate Load: Multiply Watts per Foot x Length in Feet  
**Example:** 1.5W x 30' = 45W
- Choose a driver from catalog.  
**Example:** 60 Watt Driver
- Determine maximum driver distance using Maximum Wire Length Table on drivers page.  
**Example:** 45 watts is between 40W and 60W. Using #14 wire, maximum distance is 37' from driver to first LED.

### INSTALLATION RECOMMENDATIONS

- Luminaires must be mechanically attached directly to mounting surface using mounting clips, channels, or other appropriate means. Refer to installation step by step pages for details.
- Conduit raceway should be sleeved at one end for low voltage wires going to driver.

### INSTALLATION TOOLS REQUIRED

- Electric Hammer Drill
- 14.4 to 28 Volt Cordless Drill
- Phillips Bits
- Utility Knife
- Electrical Cord
- Marker
- Wire Stripper
- Long Nose Pliers
- Drill Bits - Concrete or Wood
- Electrical Three Ways
- Safety Glasses
- Measuring Tape
- Laser Line or Chalk Line

### WARNING

When using LED Lightstrip for any application, basic safety precautions should always be followed to reduce the risk of fire, electric shock, and personal injury. LED Lightstrip must be installed in accordance with the NEC or CEC as applicable. ALUZ will not be responsible for any damage or malfunction caused by the following:

- Ensure power is off before installation begins, during replacements, additions, or repairs.
- Do not use LED Lightstrip if damaged, such as broken boards, loose connections, or frayed wire insulation. Inspect before installing.
- Do not install LED Lightstrip in hazardous locations.
- Do not cover LED Lightstrip with any material, as it may cause LEDs to overheat, melt, or ignite. **(Fig. 1)**
- Do not paint on or over fixture lens or LEDs. Paint or any other substance on lens or LEDs will cause a shift in color temperature.
- Soffit must be evenly painted with a neutral white to avoid color shift.
- Do not modify LED Lightstrip in the field.
- Do not overlap LED Lightstrip luminaires in any way.
- Only use LED Lightstrip with specified rated voltages. Do not exceed the specified voltage for any LED Lightstrip luminaire.
- Do not use LED Lightstrip extrusion as a raceway for additional wire. Non-factory feed through wires inside LED Lightstrip will void warranty.
- Ground Fault Circuit Interrupter (GFCI) protections should be provided on circuits or outlets when LED Lightstrip is used for outdoor applications.
- Surge protector must be set up for electrical power system to avoid damaging LED Lightstrip lighting system.
- Do not connect wires together, follow provided wiring diagrams.
- Do not cut wire while energized.
- Do not connect LED Lightstrip to power source while spooled or coiled. **(Fig. 2)**
- Do not exceed maximum run lengths.
- Do not mount LED Lightstrip with staples, nails, or like means that might damage the insulation. Mount with double-sided tape and mounting clips.
- Do not install mounting clips over LED diodes. **(Fig. 3)**
- Do not penetrate LED Lightstrip with any foreign object. **(Fig. 4)**
- Do not mount LED Lightstrip inside tanks or enclosures of any kind.
- Do not use improper screw head type on mounting clips. It will cause the mounting clip to open up and become dysfunctional.
- Do not modify mounting clips.
- Do not mount fixture with less than the minimum number of mounting clips required. See mounting clips section for details.
- Do not force LED Lightstrip into a space that is too small.
- Do not force LED Lightstrip with cord grip into soffit.
- Do not install LED Lightstrip at an angle within a cove. Only install fixtures straight within a cove.
- Do not bend extrusion around radius.
- Do not submerge dry or wet location LED Lightstrip in any liquid.
- Do not install wet location in outdoor coves without proper drainage. **(Fig. 5)**
- Do not install LED Lightstrip in any area that is continuously exposed to flowing or pooling water, such as underneath drain pipes, sprinklers, fountains, misters, etc.
- Do not install connectors without shrink tube for wet location. **(Fig. 6)**
- Do not use a lighter or open flame to heat shrink tube. **(Fig. 7)**
- Do not cut, puncture, or penetrate LED Lightstrip aluminum housing, end caps, or lens covers.
- Do not drop, bang, or rest weight upon LED Lightstrip.
- Do not apply excessive pressure to any part of LED Lightstrip or LEDs. **(Fig. 8)**
- Do not bend LED Lightstrip power cord or continuous connector past permitted bend radius. Bending past permitted bend radius will break the seal of the cordgrip or damage the insulation. 1.5" minimum bend radius. **(Fig. 9)**
- Do not install LED Lightstrip in a zig zag fashion. **(Fig. 10)**
- Do not fold, crease, or twist LED Lightstrip. **(Fig. 11)**
- Do not bend lightstrip along a horizontal plane. **(Fig. 12)**
- Do not overlap LED Lightstrip at any location. **(Fig. 13)**
- Do not cross or overlap extrusions and twist lightstrip to overlap. **(Fig. 14)**
- Do not install LED Lightstrip in places where the power cord is subject to continuous flexing.
- Do not twist continuous connector or power cord.
- Do not hold, carry, or suspend LED Lightstrip by the power cord.
- Do not install LED Lightstrip on ceilings without mounting clips. **(Fig. 15)**

### FIGURES

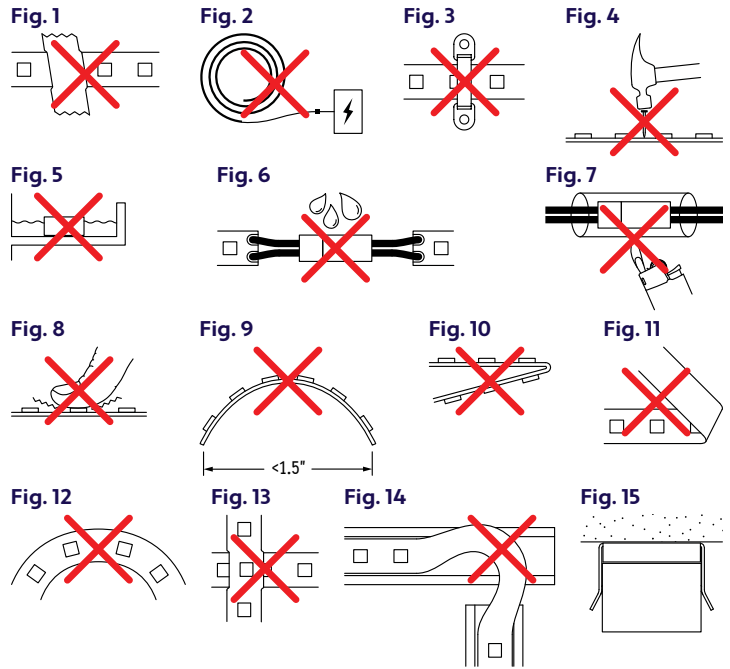

### CLEANING MATERIALS

The use of solvents and/or cleaners which are not compatible with polycarbonate will result in the softening, crazing, and/or cracking of the plastic part. This is especially true of polycarbonate lamps and mounting bases which may be under stress in their normal applications.

### COMPATIBLE WITH POLYCARBONATE

- Mild soap and water
- Mineral Spirits
- Isobutyl Alcohol
- VM and P Naphtha
- Varsol No.2
- Mexane
- Freone TF and TE-35
- Ethanol
- Dirtex
- 2% Sol. Reg. Joy
- 10% Sol Bon Ami
- White Kerosene
- Methyl Alcohol
- Heptane
- Petroleum Ether / 65°C
- Isopropyl Alcohol
- Lacryl PCL-2035
- Polycarbonate Cleaner

### NOT COMPATIBLE WITH POLYCARBONATE

- Trichlor
- Gasoline
- Liquid Detergents
- Acetone
- Carbon Tetrachloride
- Pink Lux (Phosphate free)
- Triclene
- Chlorinated Hydrocarbons
- #1 & #3 Denatured Alcohol
- Methyl Ethyl Keytone (MEK)
- Texize-8006, 8129, 8758
- MIBK
- Liquid Cleaner - 8211
- Toluol
- Agitene
- Benzol
- Ajax
- Kleenol Plastics
- Lysol
- Stanisol Naphtha
- Oils
- Lemon Joy (phosphate free)
- Diversol
- Lestoil

### DIAGRAM OF DRIVER

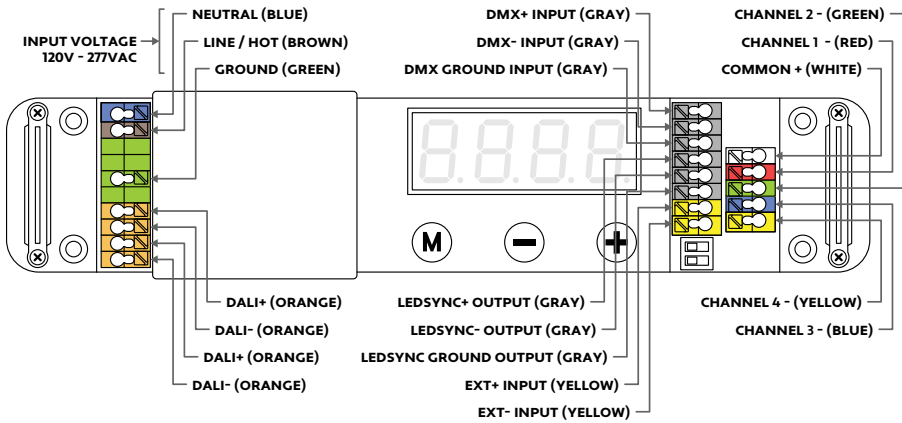

### DIGITAL INTERFACE

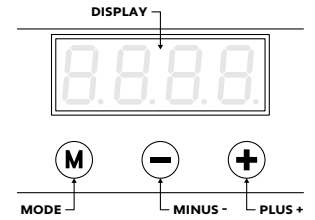

### NOTES (DMX)

- Wire colors on diagram correspond to colors of driver terminals.
- Default DMX address of each luminaire is 001. Consult a third party DMX commissioner to modify at time of installation. ALUZ does not provide DMX commissioning.
- DMX Address must be set for each driver. Default DMX address is 001.
- A DMX Control System (by others) must be used to operate the lighting.
- The last driver in a daisy chain sequence must be terminated.
- Driver load not to exceed 100W.
- For best dimming performance, it is recommended to load drivers to a minimum of 50% (50W) and a maximum of 80% (80W).
- Up to 28 drivers may be daisy chained together using shielded cable specified for DMX wiring.
- Ensure DIP Switch 1 is set to ON (Left) to activate 24V operation.

#### DMX Wiring: Static White

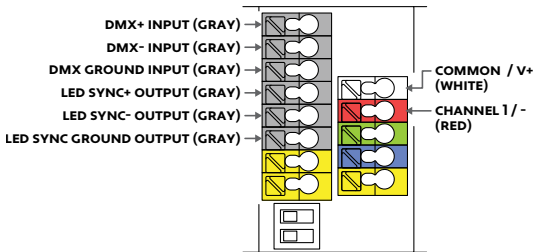

#### DMX Wiring: RGBW

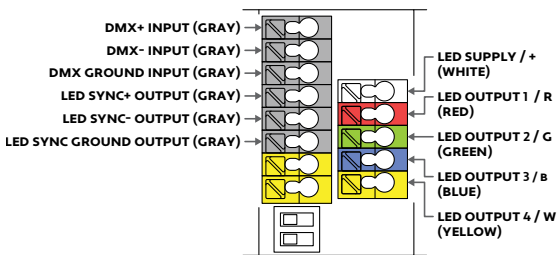

#### DMX Wiring: Dynamic White (DWH)

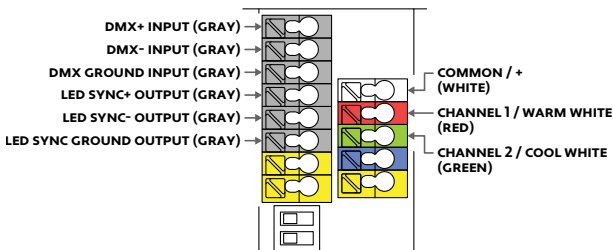

### DMX Daisy Chain

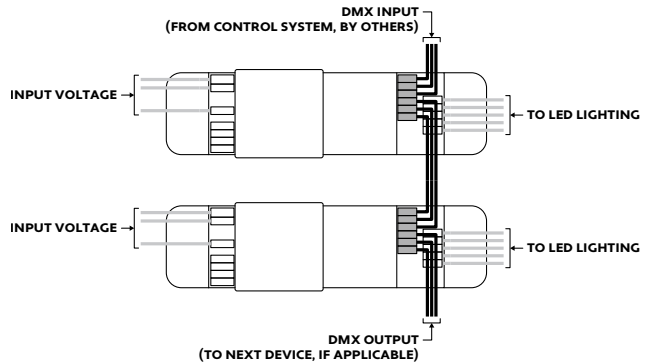

### NOTES (DALI)

- Wire colors on diagram correspond to colors of driver terminals.
- DALI commissioning to be performed by a third party at time of installation. ALUZ does not provide DALI commissioning.
- DALI Address must be set for each driver.
- A DALI Control System (by others) must be used to operate the lighting.
- Driver load not to exceed 100W.
- For best dimming performance, it is recommended to load drivers to a minimum of 50% (50W) and a maximum of 80% (80W).
- Up to 28 drivers may be daisy chained together using shielded cable specified for DALI wiring.
- Ensure DIP Switch 1 is set to ON (Left) to activate 24V operation.

### DALI Daisy Chain

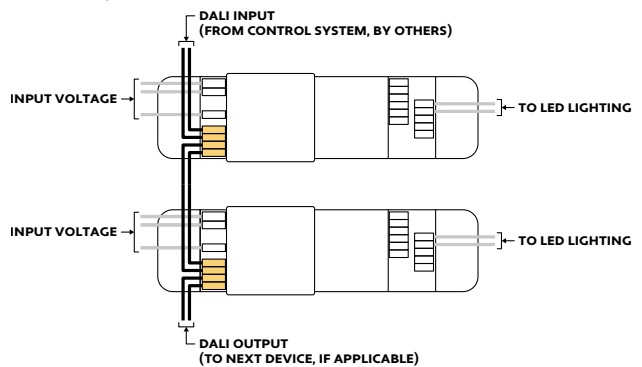

### MODE OF OPERATION

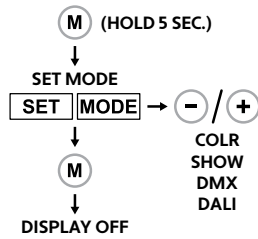

• Set Mode to DMX or DALI

### SET LED GROUPS

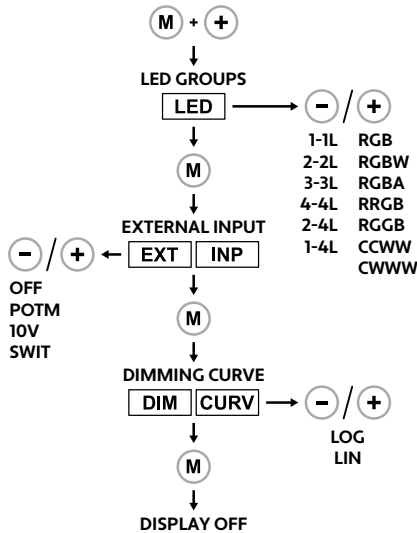

- Set LED Groups to RGBW for RGBW lighting.
- Set LED Groups to CCWW for Dynamic White lighting.
- Set External Input to OFF.
- Set Dimming Curve to Linear.

### STANDALONE OPERATION (Network Operation)

#### Set DMX Address

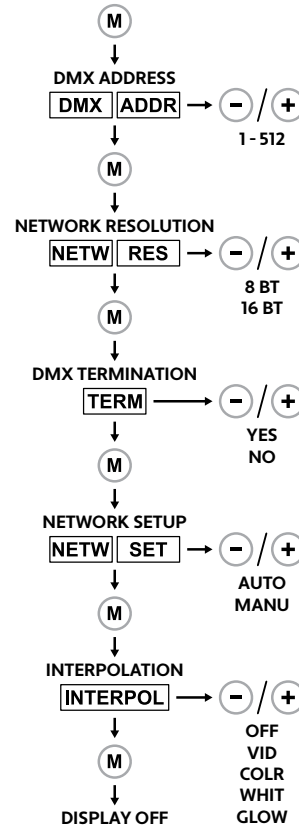

#### Set DALI Address

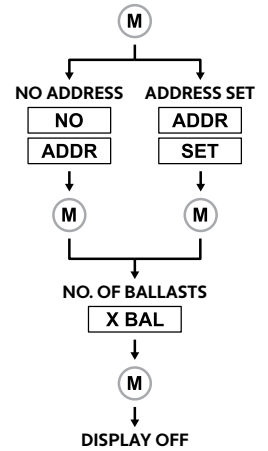

- Consult with a third-party DMX or DALI professional to determine which settings are best for your application. ALUZ does not provide DMX or DALI commissioning.

### OTHER FUNCTIONS

#### Visual Test



#### Reset Settings

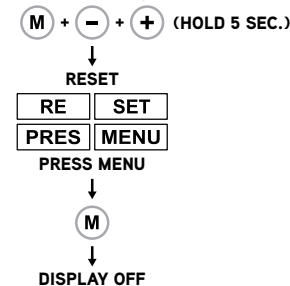

#### Lock Driver

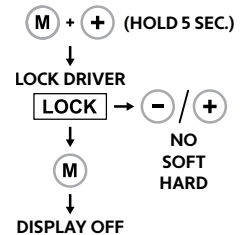

- Always perform the visual test function after wiring to ensure all channels are behaving appropriately.
- Reset driver to factory settings if necessary. It is recommended to reset each driver before adjusting settings for the first time.
- Lock driver if applicable (not recommended).

### STANDALONE OPERATION (Color / Show)

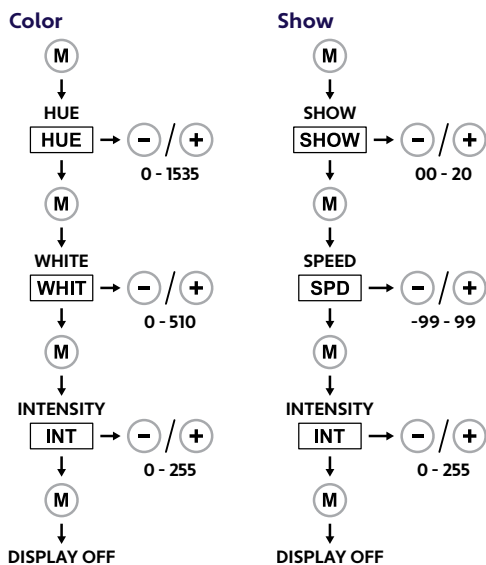

- Standalone Operation should only be used when a control system is not present to control the lighting (not recommended).

### APPLICATION GUIDELINES

- Follow the below diagrams and steps if applicable to your installation.
- LED lightstrip and modules require a team effort to ensure a secure and correct installation.
- Use a wire puller stand to prevent tangles, twists, and snags.
- For Mud-In applications, start lightstrip from power source side and allow up to 2" of excess lightstrip to exit through end cap.

### NOTE

- Extrusions are shipped to exact length of specified measurements.
- Due to cut increment restrictions (4", +/- 0.125" Tolerance), the lightstrip is shipped to the closest measurement ordered. The lightstrip must be centered in the extrusion.
- Remove adhesive backing completely to allow heat transfer tape to make contact with the aluminum extrusion.

### LED LIGHTSTRIP

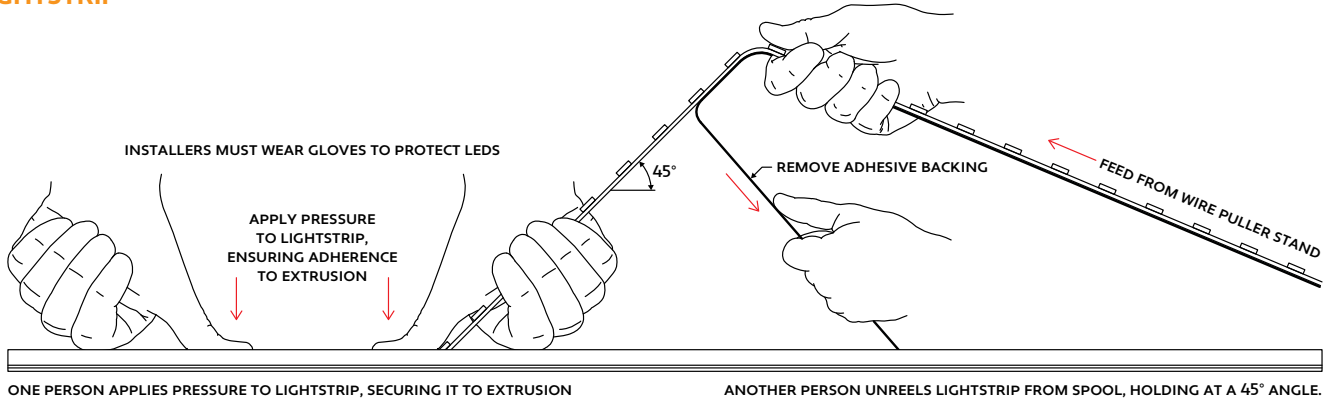

### SOLDERING GUIDE

**Note:** Appearance of lightstrip may differ from example shown. Refer to wiring diagrams before soldering any wires.

- 1 Cut lightstrip to desired length. Include both sets of solder pads by cutting to the left or right of designated markings, allowing more space for soldering.

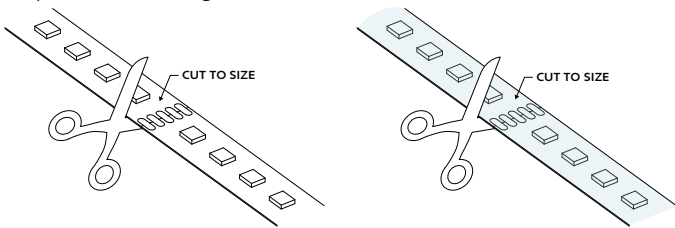

- 2 Prepare wires by stripping 1/8" from the end of each wire, then tin the tips of the wire with solder. Apply heat to stripped portion of wire, then add a small amount of solder until stripped portion of wire is fully covered in solder.

- 3 If applicable, use a mat knife to remove encapsulation from the section of lightstrip with solder pads. If lightstrip is not encapsulated, skip this step.

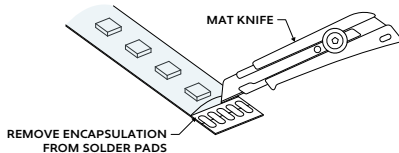

- 4 Solder lead wires to solder pads on the end of lightstrip.

- Solder the Black wire to the pad marked "+24V".
- Solder the Green wire to the pad marked "G".
- Solder the Red wire to the pad marked "R".
- Solder the Blue wire to the pad marked "B".
- Solder the White wire to the pad marked "W".

**Note:** Solder iron not to exceed 720°F. Heat joint with tip of iron. Heat both the solder pad and the wire. Add a small drop of solder on the tip of solder iron to transfer the heat to joint quickly; it should melt and flow smoothly, covering the wire and pad. Remove iron once enough solder has been added to the components. Allow 5 seconds for the joint to cool.

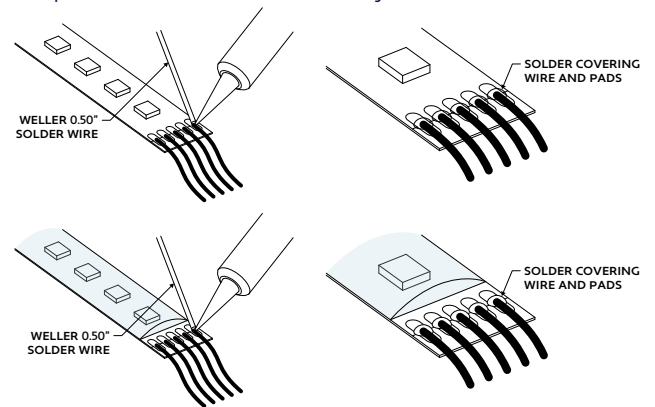

- 5 If applicable, apply silicone over soldered connections. All connections must be completely covered with silicone to create weatherproof seal. Only use outdoor rated silicone. If lightstrip is not encapsulated, skip this step.

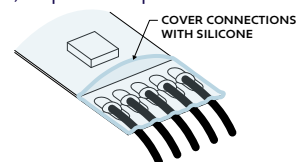

### EXAMPLE: 90° MITER

Miter cuts are only to be performed on unassembled dry location products. Do not attempt to modify wet location products.

- 1 Measure area where mitered fixture will be installed. Cut extrusion and lens to size +1".  
**Example:** 7'8" extrusion to meet 1'5" extrusion. Cut extrusions to 7'9" and 1'6"  
**Note:** Plan your cuts so that lens will always overlap where two extrusions meet. Overlapping lenses helps keep extrusions in line and prevents light leaks.

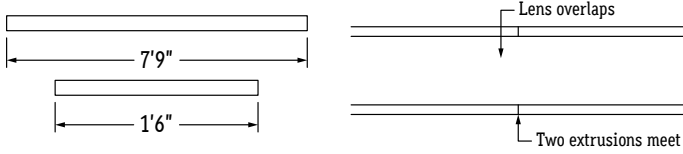

- 2 Measure angle where fixture will be mitered. Use an angle finder to determine exact angle.  
**Example:** 90° Angle

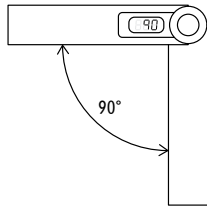

- 3 Divide measured angle by 2 ( $90° \div 2 = 45°$ ). Set miter saw to 45° and cut the end of each extrusion and lens where they will intersect. Verify the miter closes properly and fits in area, then trim excess extrusion on the end without the miter to exact size.

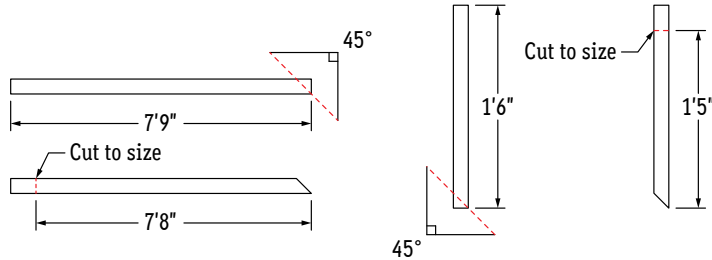

- 4 Use a small segment of wire to solder lightstrips between mitered extrusions. Do not bend lightstrip to turn corner. Refer to application guidelines for soldering steps.

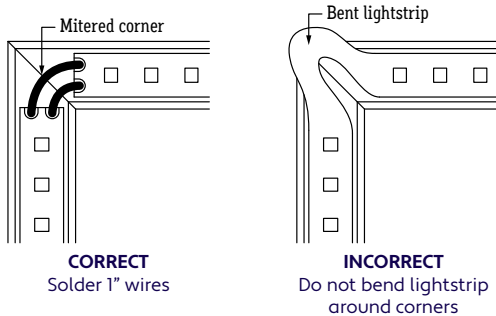

### EXAMPLE: 135° MITER

- 1 Measure area where mitered fixture will be installed. Cut extrusion and lens to size +1".  
**Example:** 7'8" extrusion to meet 1'5" extrusion. Cut extrusions to 7'9" and 1'6"  
**Note:** Plan your cuts so that lens will always overlap where two extrusions meet. Overlapping lenses helps keep extrusions in line and prevents light leaks.

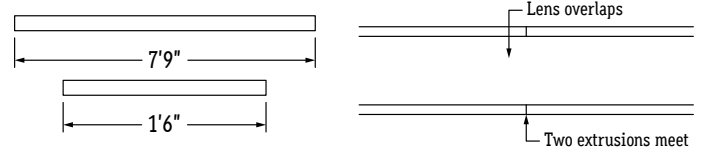

- 2 Measure angle where fixture will be mitered. Use an angle finder to determine exact angle.  
**Example:** 135° Angle

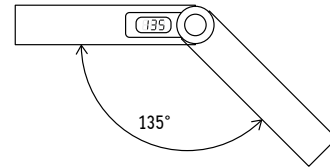

- 3 Divide measured angle by 2 ( $135° \div 2 = 67.5°$ ). Set miter saw to 67.5° and cut the end of each extrusion and lens where they will intersect. Verify the miter closes properly and fits in area, then trim excess extrusion on the end without the miter to exact size.

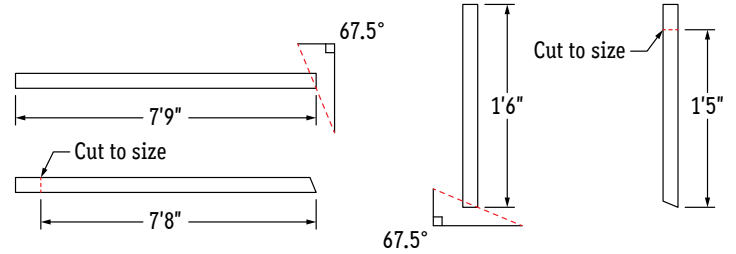

- 4 Use a small segment of wire to solder lightstrips between mitered extrusions. Do not bend lightstrip to turn corner. Refer to application guidelines for soldering steps.

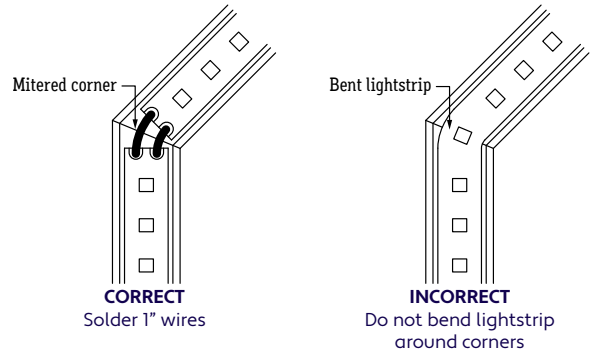



### MOUNTING GUIDELINES

- 1 Hang drywall according to the diagram below. If drywall is already hung, a channel must be cut.

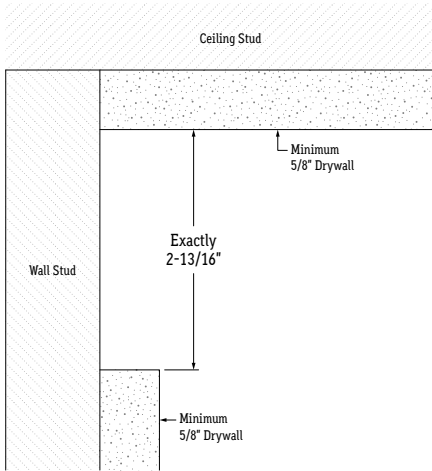

- 2 Mount extrusions to wall studs using countersink screws. Drill countersink holes in flange as needed. Each flange must be mounted to studs with at least 1 screw every 2', rounded up. **Note:** Screws must be long enough to penetrate drywall and wall stud. **Note:** 1/8" Gap tolerance for extrusions butted together.

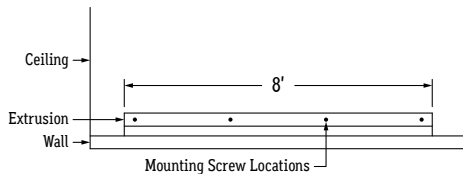
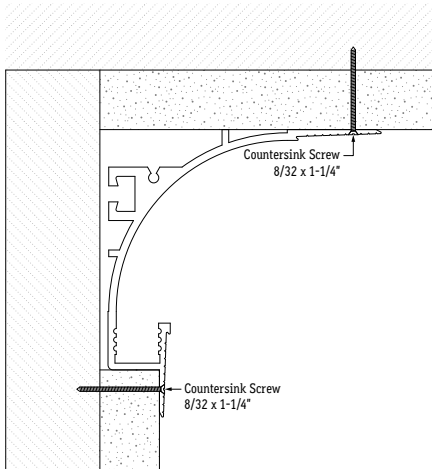

Note: One flange pictured above.  
Diagram must be followed for both flanges.

### MOUNTING GUIDELINES

- 1 Apply drywall tape to edges of flange and drywall. **Note:** Use ultra-thin drywall tape. Do not overlap drywall tape.

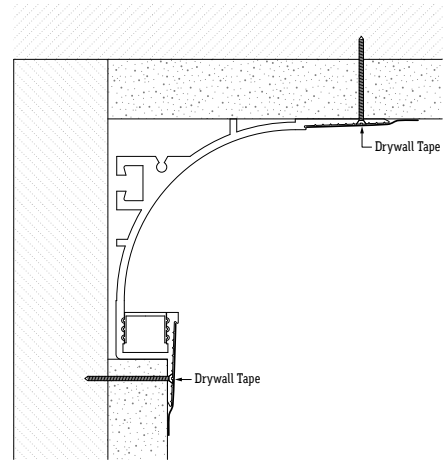

- 2 Use painters tape to tape off extrusion lens and trim. Ensure the trim area, circled in red below, is fully covered with tape.

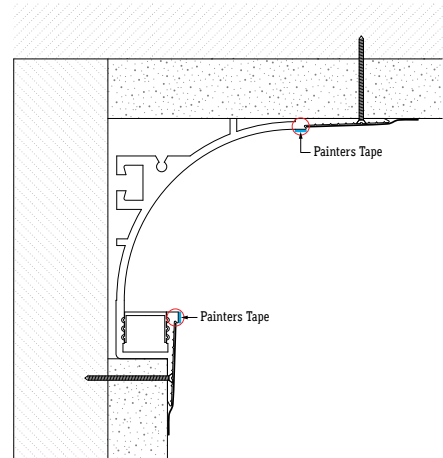

- 3 Apply 1/8" mud, completely covering flange and drywall tape. **Note:** Do not use any pre-mixed mud compounds.

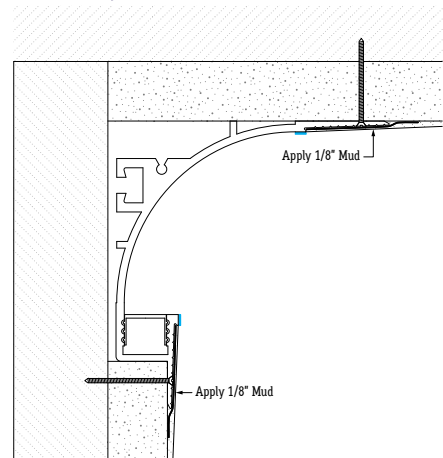

- 1 Hang drywall according to Step 1 of Mounting Guidelines. If drywall is already hung, follow Steps 2 - 4 below. If drywall is hung to guidelines, start at Step 5.

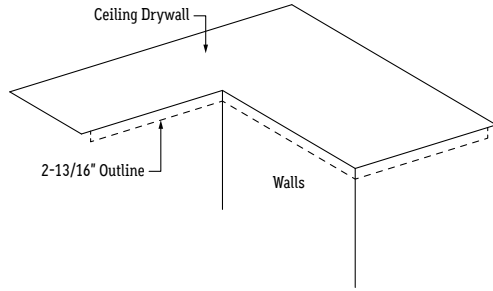

- 2 Measure area where fixtures will be installed. Use a laser level to create a 2-13/16" outline on ceiling where luminaires will be installed. Add 1" to total length for each end cap used.  
**Note:** Must use minimum 5/8" drywall.

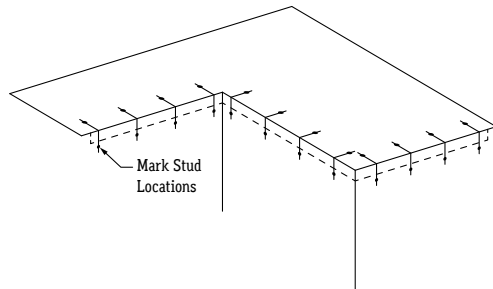

- 3 Determine location of ceiling and wall studs using a stud finder. Mark location of studs on either side of the outline, then connect each stud mark with a line.  
**Note:** Must use minimum 5/8" ceiling drywall.

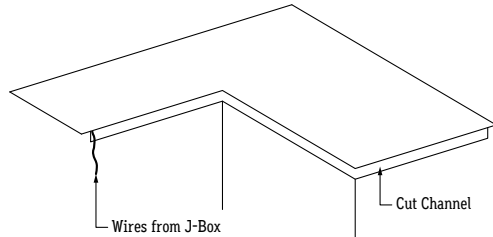

- 4 Cut a 2-13/16" channel along reference line. Do not damage studs during cutting. Pull power lead from wall after channel is cut.

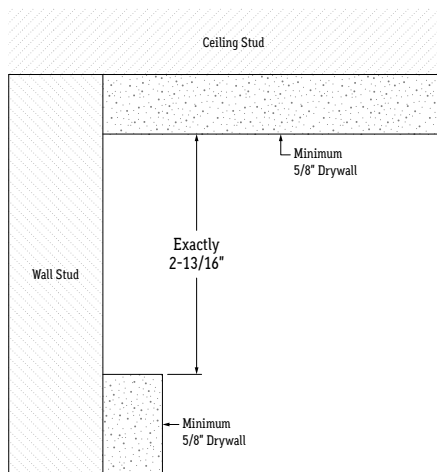

- 5 Mount corner segments to drywall.  
**Note:** Refer to Mounting Guidelines to ensure correct installation.

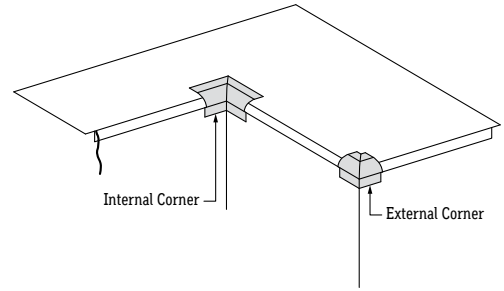

- 6 Measure exact distance between mitered corner extrusions and cut linear extrusions to exact size.

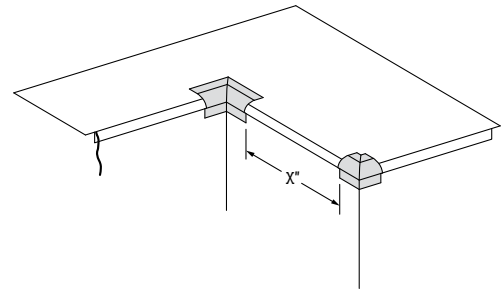

- 7 Mount linear extrusions to drywall.  
**Note:** Refer to Mounting Guidelines to ensure correct installation.

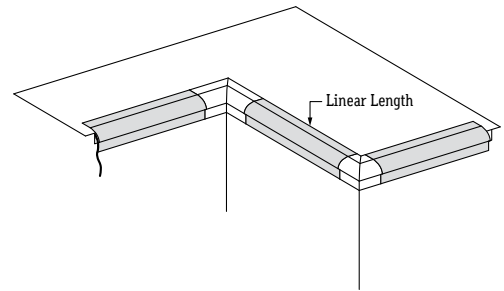

- 8 Mount end caps that will not have a power lead connection.

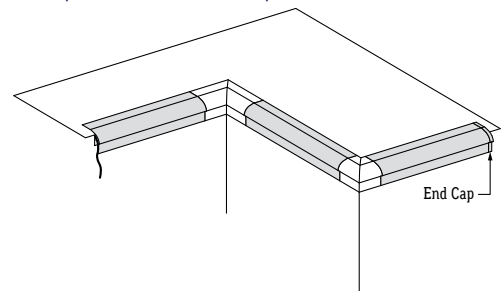





## A8 Series | LED Tape ZIZA Flush Arc Half (A8-ZIZA-FAH)

- 9** Install lightstrip into extrusion channel, starting at end with power lead. Allow any excess lightstrip to exit through end cap at terminating end.  
**Note:** Refer to **Application Guidelines and Miter Cut Guidelines** to ensure correct installation.  
**Note:** Entire lightstrip must be mounted on bottom surface of channel. Improper mounting of lightstrip will prevent lens from snapping in.

---
- 10** Feed power connector from lightstrip through end cap and make connection to power source from the inside of wall. Push excess wire through end cap and into the wall, then mount end cap.

---
- 11** Install lens into extrusions, overlapping where two extrusions meet. Plan your cuts so that the lens will always overlap where two extrusions meet. Overlapping lenses helps keep extrusions aligned and prevents light leaks.

---
- 12** After lighting is assembled and tested, follow the steps from Mud-In Guidelines to apply mud and complete installation.

---
- 13** Perform a continuity test before connecting luminaire to power source.

### TROUBLESHOOTING TIPS

- Do not reset the breaker multiple times
- If the unit is overloaded, the breaker will trip, shutting off the transformer and lights
- If the breaker reset button has been held down by hand or any type of pressure, such as duct tape, or if the breaker has been reset multiple times without troubleshooting, the unit will:
  - Burn the transformer bobbin
  - Burn the thermal or magnetic breaker
  - Burn the primary or secondary wires due to high amperage caused by overload
  - Short circuit in line which will not allow the breaker to reset
  - Damage the lighting

- 1 Turn off power before beginning. Check for any twisting or damage to the circuit in the LED lightstrip. If there is excessive damage and the circuit is broken, the lightstrip must be replaced.

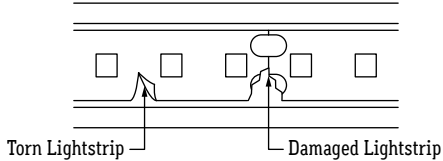

- 2 Check for metal particles or other foreign objects causing the short.

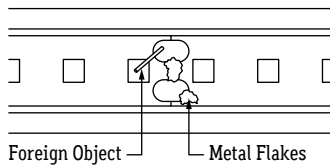

- 3 Check to make sure cuts in the lightstrip are clean and not frayed, causing positive and negative copper pads to touch.

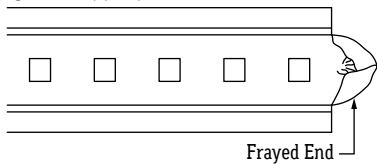

### CONTINUITY TEST

A continuity test is performed to determine if electricity can pass through two points on an electrical circuit. This helps identify shorts or malfunctions in the line or fixture. Use a multimeter or continuity tester to perform the steps below.

- Always perform a continuity test before connecting lighting to power source.
- Malfunctions are not always as obvious as the lights not turning on.
- A short or malfunction in the line or fixture will cause damage over time, ultimately damaging the lighting and voiding warranty.

- 1 Turn power off before beginning. Verify power is turned off by using a non-contact circuit tester. Touch the probe of the tester to positive wire of the power source. The tester will light up if an electrical current is detected.

- 2 Setup your tester. First insert the black probe lead into the COM jack, then insert the red probe lead into the VΩ jack.

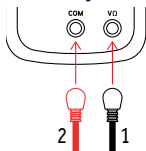

- 3 Verify that your tester is functional by touching probes together. The tester should light up, beep, or read 0Ω (ohms) of resistance.

- 4 Touch the red probe to the black wire and the black probe to each colored wire. If a conductive path is formed between the black wire and any other wire, the multimeter will beep, flash, or read 0Ω (ohms). Troubleshoot to identify the malfunction in the line. If there is no conductive path, the multimeter will not show any feedback.

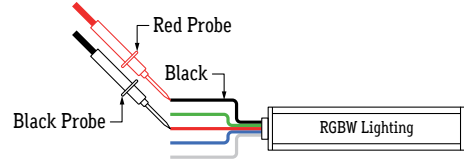

- 5 Touch the red probe to the fixture extrusion and the black probe to the black wire. If a conductive path is formed between the extrusion and the black wire, the multimeter will beep, flash, or read 0Ω (ohms). Troubleshoot to identify the malfunction in the line. If there is no conductive path, the multimeter will not show any feedback.

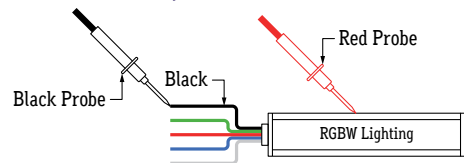

- 6 Touch the red probe to the fixture extrusion and the black probe to the each colored wire. If a conductive path is formed between the extrusion and any colored wire, the multimeter will beep, flash, or read 0Ω (ohms). Troubleshoot to identify the malfunction in the line. If there is no conductive path, the multimeter will not show any feedback.

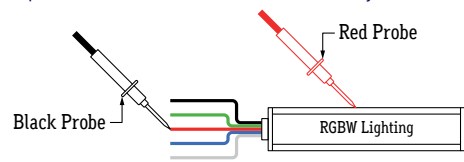

- 7 Set voltmeter to DC voltage and test power source. Confirm the correct voltage before connecting lighting to power source. If voltage reading is more than 1 volt higher than the marked output voltage, there is a problem with the power source or driver.

- 8 Connect power connector to power source. If LEDs do not turn on, flip polarity (+ -) or power source connection to power connector.