

END VIEWS / DIMENSIONS

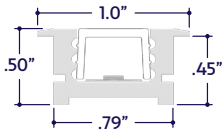

LENS / OPTICS APPEARANCE



Clear Lens (CL)
Visible Diode Image
0% Light Loss



50% Semi-Frosted Lens (SF)
Slight Diode Image
12.5% Light Loss



100% Frosted Lens (F)
No Diode Image: Line of Light
25% Light Loss

MOUNTING OPTION



Recessed Mount

GENERAL FEATURES

Applications	Accent, Decorative, Surface, Recess, Pendant Lighting
Lens	Clear, 50% Semi-Frosted, or 100% Frosted
Viewing Angle	120°
Length	Built to Order (+/- 1/8" Tolerance)
Construction	Aluminum Extrusion
Weight	0.261 lbs per foot
Mounting	Mounting Channel
Listing	Dry, Wet, or IP67 Location UL2108, 67.1.9, 60.4, CSA C22.2 #9 UL8750, CSA250
Driver	Remote (Sold Separately)
Temperature Ratings	Operating / Startup: -20° to 48°C (-4° to 120°F) Storage: -40° to 76°C (-40° to 170°F)

Installation Link

ELECTRICAL

Dimming	DMX
Maximum Run (Class 1 Applications)	26' (4.5W) 33' (3.6W)
Maximum Run (Class 2 Applications)	21' (4.5W) 26' (3.6W)
Luminaire Voltage	24VDC

SPECIFY PRODUCT CODE | CHOOSE FROM DROP DOWNS

Series	Lens	Watts per Foot	Dimming	LED	Listing	Finish	Luminaire Length
A8-ZUDA-RCD			DMX	DWH			
ZUDA Recessed (A8-ZUDA-RCD)	Clear Lens (CL)	3.6 Watts (3.6W)	DMX-512*1 (DMX)	2400K - 6400K (DWH)	Indoor (DRY)	Natural Silver*3 (NA)	Specify Length in Feet & Inches Example: 7'8"
	50% Semi-Frosted Lens (SF)	4.5 Watts (4.5W)			Outdoor*2 (WET)	Polished (PA) White (WH)	
	100% Frosted Lens (F)				Outdoor IP67*2 (IP67)	Satin / Silver (SA) Black (BK)	

*1 Default DMX address of each luminaire is 001. Consult third party DMX commissioner to modify at time of installation.

*2 Run lengths are required for Wet & IP67 Location products. Provide run lengths at time of order.

*3 Default finish is Natural Silver (NA) if left blank.



LAMP SPECIFICATIONS

Lamp Number	Correlated Color Temperature (CCT) Gamut	L70 LED Life
DWH	Dynamic White: 2400K - 6400K	50,000 hrs.

LAMP FEATURES

Lamp Type	Dynamic White LEDs: 2400K - 6400K
CRI	> 90

BEAM ANGLE

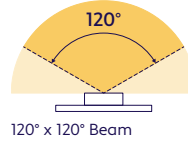

DRIVERS

Dimming Selection	Product Code	Link to Specification Sheet / URL
DMX-512*	(DMX)	

MOUNTING OPTIONS (Sold Separately)

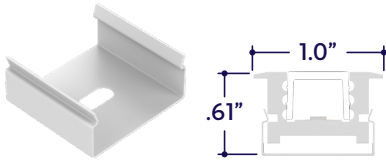

Part #	Qty.
A8-ZUDA-RCD-MC	

Note: Use 1 mounting clip per 2', rounded up.
Click on image to see cut sheet for additional details.

END CAPS (Sold Separately)

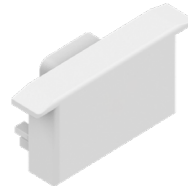

End Cap
(A8-ZUDA-RCD-EC)

Part #	Qty.
A8-ZUDA-RCD-EC	

Note: Use 1 End Cap for each termination without power feed.

DRY CONNECTORS (Sold Separately)



Part #	Length	Qty.
A8-PC-3P-DRY-	36"	
A8-PC-3P-DRY-		

Note: Connector style subject to change without notice.
Refer to cut sheet for wiring colors.



Part #	Length	Qty.
A8-CC-3P-DRY-	3"	
A8-CC-3P-DRY-		

Note: Connector style subject to change without notice.
Refer to cut sheet for wiring colors.

DMX CONTROLLERS (Sold Separately)



Part #	Qty.
DRV100-E-UNV-24VDC-DMX-DRY	

Note: Use 1 Driver / Decoder for each run up to 100 Watts.



Part #	Qty.
CTRL-DMX-RGBX	

Note: Use 1 Decoder for each run up to 96 Watts. Not required if using all-in-one driver / decoder (DRV100-E).

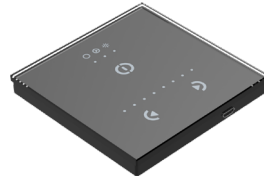

Part #	Qty.
CTRL-DMX-128C	

Note: Controls up to 128 DMX Channels.



Part #	Qty.
CTRL-DMX-1024C	

Note: Controls up to 1024 DMX Channels.



DESIGN GUIDELINES

Individual Fixture

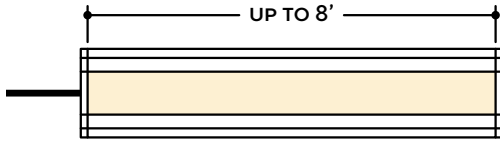

Continuous Run (Dry or Wet Location)

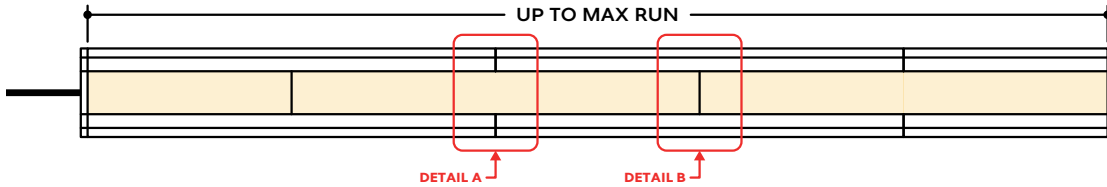

Runs with Continuous Connector (Dry Location)

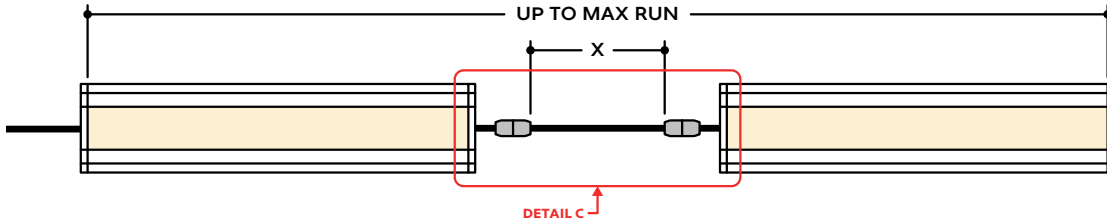

Runs with Continuous Connector (Wet Location)

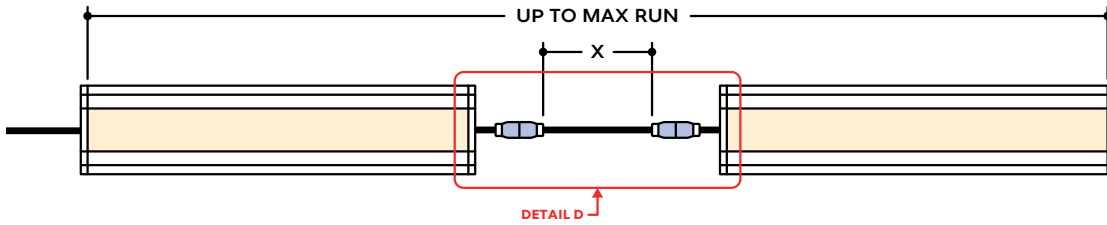

KEY

- Detail A Two Extrusions Meet:** Two extrusion segments meet, held together by a mounting clip. Refer to installation instructions for additional details.
- Detail B Two Lenses Meet:** Lenses are staggered so that the lens always overlaps where two extrusion segments meet. Refer to installation instructions for additional details.
- Detail C Dry Continuous Connector:** Used to span a corner or traverse a gap, corner, or obstacle in a dry location installation area.
- Detail D Wet Continuous Connector:** Used to span a corner or traverse a gap, corner, or obstacle in a wet location installation area.

Note: Drawings not to scale. Product may differ from examples shown.

CONNECTION SEQUENCE

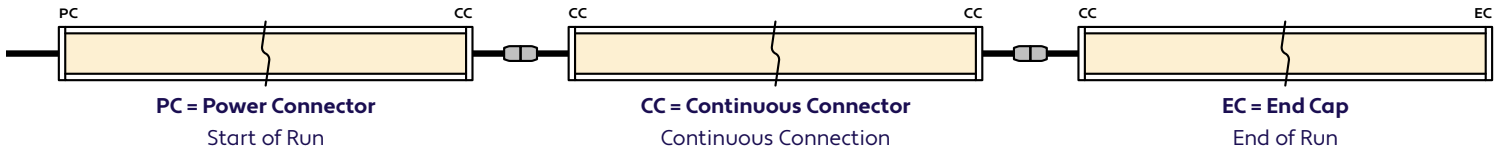

- Specifying a layout is not required to place an order.
- Configuration code applies to full length ordered and will be built per the Continuous Run models on Design Guidelines.
- Connector type subject to change based on availability and listing. Refer to Design Guidelines for details.

HOW TO SPECIFY CONFIGURATIONS

Example: 20' Straight Run

- 1x A8-ZUDA-RCD-CL-3.6W-DMX-DWH-DRY-NA-20'-PC-EC

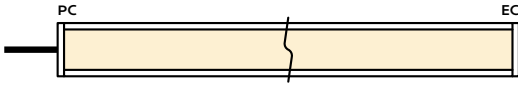

Example: 25' L-Shaped Run

- 1x A8-ZUDA-RCD-CL-3.6W-DMX-DWH-WET-NA-12'-PC-CC
- 1x A8-ZUDA-RCD-CL-3.6W-DMX-DWH-WET-NA-6'-CC-EC

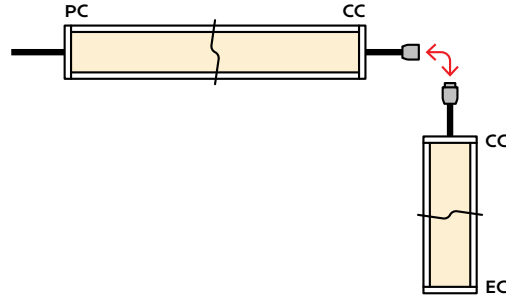

Example: 30' U-Shaped Run

- 1x A8-ZUDA-RCD-CL-3.6W-DMX-DWH-DRY-NA-6'-PC-CC
- 1x A8-ZUDA-RCD-CL-3.6W-DMX-DWH-DRY-NA-18'-CC-CC
- 1x A8-ZUDA-RCD-CL-3.6W-DMX-DWH-DRY-NA-6'-CC-EC

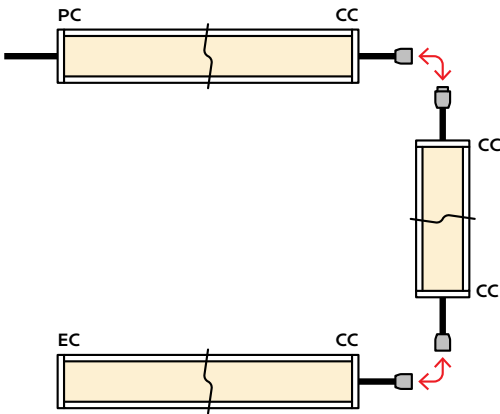

Example: 28' Rectangle Shaped Run

- 1x A8-ZUDA-RCD-CL-3.6W-DMX-DWH-WET-NA-11'-PC-CC
- 1x A8-ZUDA-RCD-CL-3.6W-DMX-DWH-WET-NA-3'-CC-CC
- 1x A8-ZUDA-RCD-CL-3.6W-DMX-DWH-WET-NA-11'-CC-CC
- 1x A8-ZUDA-RCD-CL-3.6W-DMX-DWH-WET-NA-3'-CC-EC

