

### GENERAL FEATURES

<b>Applications</b>	Direct View, Accent, Decorative, Surface Lighting
<b>Lens</b>	Clear, 50% Semi-Frosted, or 100% Frosted
<b>Viewing Angle</b>	120°
<b>Length</b>	Built to Order (+/- 1/8" Tolerance)
<b>Construction</b>	Aluminum Extrusion
<b>Field Cutting</b>	Dry and Damp Location Field Cuttable
<b>Weight</b>	0.81 lbs per Foot
<b>Mounting</b>	Mounting Clips (Sold Separately)
<b>Listing</b>	Dry or Damp Location UL2108, 67.1.9, 60.4, CSA C22.2 #9 UL8750, CSA250
<b>Driver</b>	Remote (Sold Separately)
<b>Closet Rating</b>	Up to 3.6 Watts per Foot Maximum
<b>Temperature Ratings</b>	Operating / Startup: -20° to 48°C (-4° to 120°F) Storage: -40° to 76°C (-40° to 170°F)
<b>Installation Link</b>	

### END VIEW / DIMENSIONS

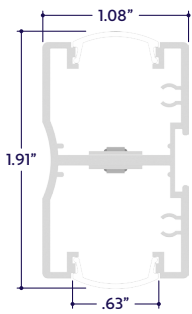

### ELECTRICAL

<b>Dimming</b>	DMX, DALI
<b>Maximum Run (Class 1 Applications)</b>	26' (9W), 33' (7.2W)
<b>Maximum Run (Class 2 Applications)</b>	9' (9W), 11' (7.2W)
<b>Luminaire Voltage</b>	24VDC

### SPECIFY PRODUCT CODE | CHOOSE FROM DROP DOWNS

Series	Lens	Watts per Foot	Dimming	LED	Listing	Finish	Luminaire Length
<b>A8-ZUDA-SWD</b>				<b>DWH</b>			
ZUDA Side Wall Duo (A8-ZUDA-SWD)	Clear Lens (CL)	3.6 Watts + 3.6 Watts (7.2W)	DMX-512* <sup>1</sup> (DMX)	2400K - 6400K (DWH)	Indoor (DRY)	Natural Silver* <sup>3</sup> (NA)	Specify Length in Feet & Inches Example: 7'8"
	50% Semi-Frosted Lens (SF)	4.5 Watts + 4.5 Watts (9W)	DALI* <sup>2</sup> (DALI)		Outdoor (DAMP)	Polished (PA) White (WH)	
	100% Frosted Lens (F)					Satin / Silver (SA) Black (BK)	

- \*<sup>1</sup> Default DMX address of each luminaire is 001. Consult third party DMX commissioner to modify at time of installation.
- \*<sup>2</sup> DALI commissioning to be performed by a third party at time of installation. ALUZ does not provide DALI commissioning.
- \*<sup>3</sup> Default finish is Natural Silver (NA) if left blank.



### LAMP FEATURES

<b>Lamp Type</b>	Dynamic White LEDs: 2400K - 6400K
<b>CRI</b>	> 90
<b>Efficacy*</b>	117 Lumens per Watt @ Lowest CCT ( <b>24K</b> ) 129 Lumens per Watt @ Highest CCT ( <b>64K</b> )

**Note:** Efficacy is based on 24K CCT LED (**24K**) with Clear Lens (**CL**).

### BEAM ANGLE

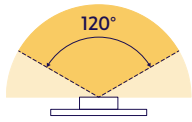

120° x 120° Beam

### DRIVERS

Dimming Selection	Product Code	Link to Specification Sheet / URL
DMX-512	(DMX)	
DALI	(DALI)	

### MOUNTING OPTIONS (Sold Separately)

**Note:** Mounting clips are only available in Natural Silver Finish, unless otherwise specified.

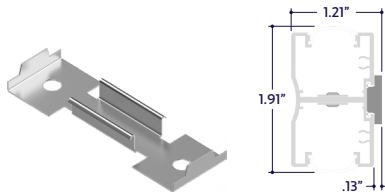

Part #	Qty.
A8-ZUDA-SWD-MC	

**Note:** Use 1 mounting clip per 2', rounded up.  
Click on image to see cut sheet for additional details.

### LAMP SPECIFICATIONS

Lamp Number	Correlated Color Temperature (CCT) Gamut	L70 LED Life
DWH	Dynamic White: 2400K - 6400K	50,000 hrs.

### LENS / OPTICS APPEARANCE



Clear Lens (**CL**)  
Visible Diode Image  
0% Light Loss



50% Semi-Frosted Lens (**SF**)  
Slight Diode Image  
12.5% Light Loss



100% Frosted Lens (**F**)  
No Diode Image: Line of Light  
25% Light Loss

### END CAPS (Sold Separately)



End Cap  
(A8-ZUDA-SWD-EC-X)  
X = Specify Finish: White (**WH**) or Black (**BK**)

Part #	Qty.
A8-ZUDA-SWD-EC-WH	
A8-ZUDA-SWD-EC-BK	

**Note:** Default Finish is Black (**BK**) if unspecified.



End Cap with Exit Hole  
(A8-ZUDA-SWD-EC-H-X)  
X = Specify Finish: White (**WH**) or Black (**BK**)

Part #	Qty.
A8-ZUDA-SWD-EC-H-WH	
A8-ZUDA-SWD-EC-H-BK	

**Note:** Default Finish is Black (**BK**) if unspecified.

### DMX ACCESSORIES (Sold Separately)



Part #	Qty.
DRV100-E-UNV-24VDC-DMX-DRY-DWH	
DRV100-E-UNV-24VDC-DALI-DRY-DWH	

**Note:** Use 1 Driver for each run up to 100 Watts.  
Click on image to see Specification Submittal.



Part #	Qty.
CTRL-DMX-RGBX	

**Note:** Use 1 Decoder for each run up to 180 Watts. Not required if using DRV100-E.

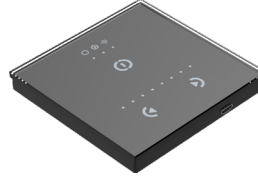

Part #	Qty.
CTRL-DMX-128C	

**Note:** Controls up to 128 DMX Channels, or up to 32 RGBW light fixtures.



Part #	Qty.
CTRL-DMX-1024C	

**Note:** Controls up to 1024 DMX Channels, or up to 256 RGBW light fixtures.

### CONNECTORS (Sold Separately)

**Note:** Connectors are factory assembled to each run length. Connectors are subject to change without notice.

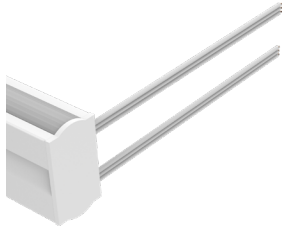

Dry Power Connector  
(20/3 Gauge Wire)  
**(A8-ZUDA-SWD-PC-SFF-DRY-X)**  
X = Specify Length, 36" Default, 25' Maximum

Part #	Length	Qty.
A8-ZUDA-SWD-PC-SFF-DRY-	36"	
A8-ZUDA-SWD-PC-SFF-DRY-		

**Note:** Specify 1 Power Connector for each lead required.  
Power Connectors are factory assembled to each length.

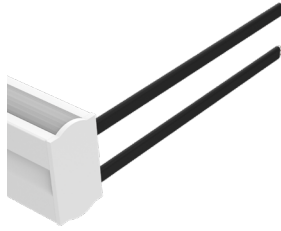

Dry Power Connector with Black Jacket  
(20/3 Gauge Wire)  
**(A8-ZUDA-SWD-PC-SFF-DRY-BK-X)**  
X = Specify Length, 36" Default, 25' Maximum

Part #	Length	Qty.
A8-ZUDA-SWD-PC-SFF-DRY-BK-	36"	
A8-ZUDA-SWD-PC-SFF-DRY-BK-		

**Note:** Specify 1 Power Connector for each lead required.  
Power Connectors are factory assembled to each length.

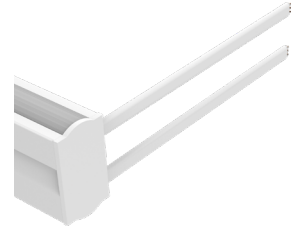

Dry Power Connector with White Jacket  
(20/3 Gauge Wire)  
**(A8-ZUDA-SWD-PC-SFF-DRY-WH-X)**  
X = Specify Length, 36" Default, 25' Maximum

Part #	Length	Qty.
A8-ZUDA-SWD-PC-SFF-DRY-WH-	36"	
A8-ZUDA-SWD-PC-SFF-DRY-WH-		

**Note:** Specify 1 Power Connector for each lead required.  
Power Connectors are factory assembled to each length.

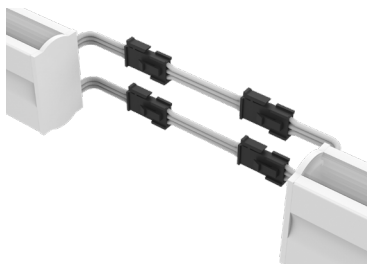

Dry Continuous Connector  
(20/3 Gauge Wire)  
**(A8-ZUDA-SWD-CC-SFF-DRY-X)**  
X = Specify Length, 3" Default

Part #	Length	Qty.
A8-ZUDA-SWD-CC-SFF-DRY-	3"	
A8-ZUDA-SWD-CC-SFF-DRY-		

**Note:** Specify Continuous Connectors to traverse a gap or obstacle. Continuous Connectors are factory assembled to specified lengths.

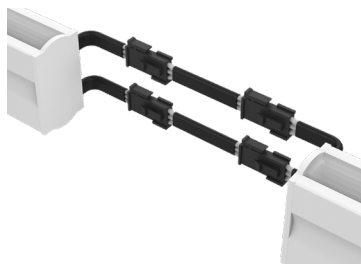

Dry Continuous Connector with Black Jacket  
(20/3 Gauge Wire)  
**(A8-ZUDA-SWD-CC-SFF-DRY-BK-X)**  
X = Specify Length, 3" Default

Part #	Length	Qty.
A8-ZUDA-SWD-CC-SFF-DRY-BK-	3"	
A8-ZUDA-SWD-CC-SFF-DRY-BK-		

**Note:** Specify Continuous Connectors to traverse a gap or obstacle. Continuous Connectors are factory assembled to specified lengths.

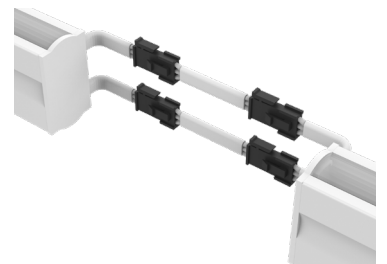

Dry Continuous Connector with White Jacket  
(20/3 Gauge Wire)  
**(A8-ZUDA-SWD-CC-SFF-DRY-WH-X)**  
X = Specify Length, 3" Default

Part #	Length	Qty.
A8-ZUDA-SWD-CC-SFF-DRY-WH-	3"	
A8-ZUDA-SWD-CC-SFF-DRY-WH-		

**Note:** Specify Continuous Connectors to traverse a gap or obstacle. Continuous Connectors are factory assembled to specified lengths.



## DESIGN GUIDELINES

### Individual Fixture

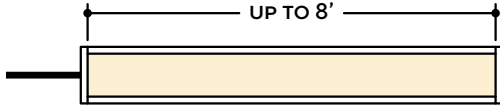

### Continuous Run (Dry or Wet Location)

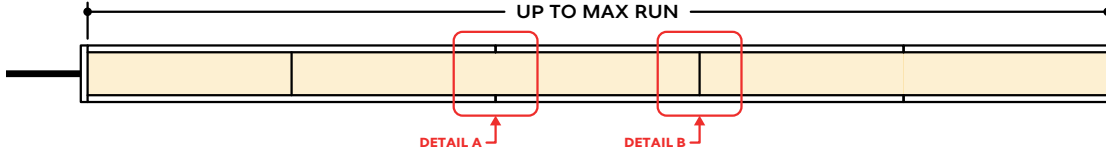

### Runs with Continuous Connector (Dry Location)

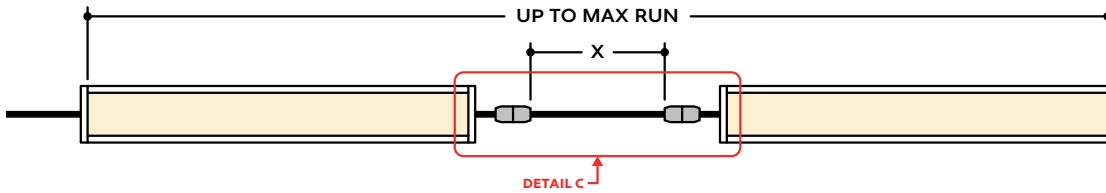

## KEY

- Detail A Two Extrusions Meet:** Two extrusion segments meet, held together by a mounting clip. Refer to installation instructions for additional details.
- Detail B Two Lenses Meet:** Lenses are staggered so that the lens always overlaps where two extrusion segments meet. Refer to installation instructions for additional details.
- Detail C Dry Continuous Connector:** Used to span a corner or traverse a gap, corner, or obstacle in a dry location installation area.

**Note:** Drawings not to scale. Product may differ from examples shown.

### CONNECTION SEQUENCE

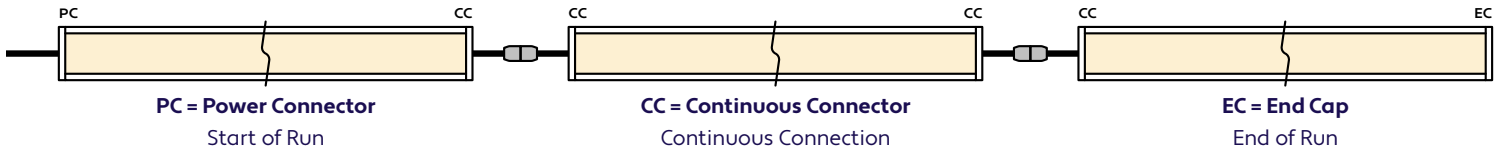

- Specifying a layout is not required to place an order.
- Configuration code applies to full length ordered and will be built per the Continuous Run models on Design Guidelines.
- Connector type subject to change based on availability and listing. Refer to Design Guidelines for details.

### HOW TO SPECIFY CONFIGURATIONS

#### Example: 20' Straight Run

- 1x A8-ZUDA-SWD-CL-7.2W-DMX-DWH-DRY-NA-20'-PC-EC

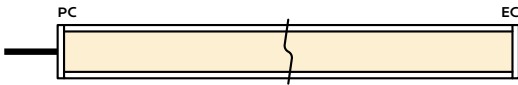

#### Example: 25' L-Shaped Run

- 1x A8-ZUDA-SWD-CL-7.2W-DMX-DWH-WET-NA-12'-PC-CC
- 1x A8-ZUDA-SWD-CL-7.2W-DMX-DWH-WET-NA-6'-CC-EC

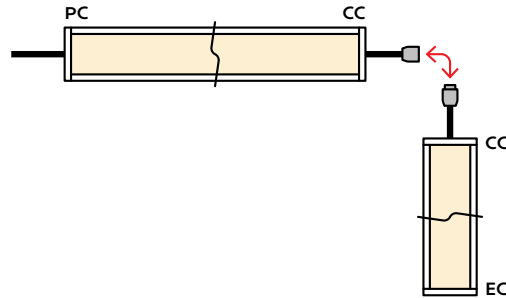

#### Example: 30' U-Shaped Run

- 1x A8-ZUDA-SWD-CL-7.2W-DMX-DWH-DRY-NA-6'-PC-CC
- 1x A8-ZUDA-SWD-CL-7.2W-DMX-DWH-DRY-NA-18'-CC-CC
- 1x A8-ZUDA-SWD-CL-7.2W-DMX-DWH-DRY-NA-6'-CC-EC

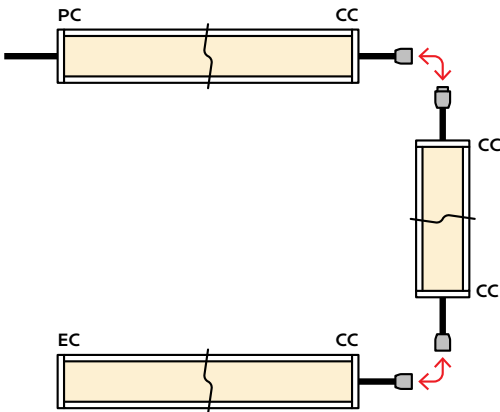

#### Example: 28' Rectangle Shaped Run

- 1x A8-ZUDA-SWD-CL-7.2W-DMX-DWH-WET-NA-11'-PC-CC
- 1x A8-ZUDA-SWD-CL-7.2W-DMX-DWH-WET-NA-3'-CC-CC
- 1x A8-ZUDA-SWD-CL-7.2W-DMX-DWH-WET-NA-11'-CC-CC
- 1x A8-ZUDA-SWD-CL-7.2W-DMX-DWH-WET-NA-3'-CC-EC

