

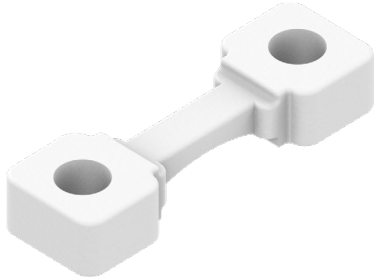

Perspective View



Assembled Dimensions



- 1 Measure area where lightstrip will be installed. Use a laser line to create a reference line along installation area, ensuring consistent alignment of mounting clips. Mark location where each mounting clip will be installed along reference line.
- 2 Remove adhesive backing from lightstrip and stick in place along reference line, ensuring lightstrip is securely mounted and free of twists, tangles, creases, bumps, or overlaps.

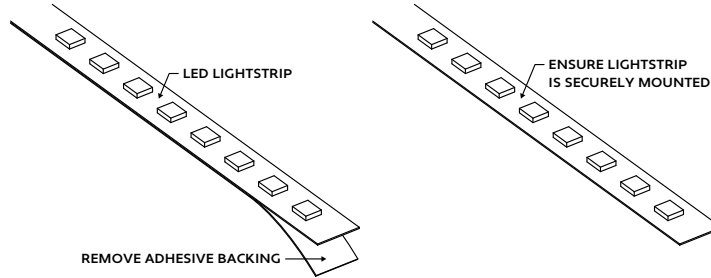

- 3 For Dry Locations applications, only use the mounting clip with the flat side facing down.

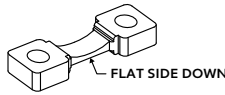

- 4 Use 1 mounting clip every 6", rounded up. Use 1 mounting clip every 4", rounded up if application is downward facing, outward facing, or vertically mounted. Lay mounting clips and pre-drill using an appropriate drill bit for surface material and screw size.
Recommendation: 8/32 x 1" screw.

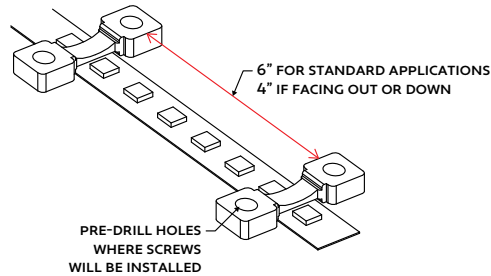

A8 Series | LED Tape ZUDA Tape - Mounting Clip (A8-ZUDA-TAPE-MCS)

- 5 Screw mounting clips to surface, securing lightstrip to surface.
Note: Do not install clips over LED diodes.

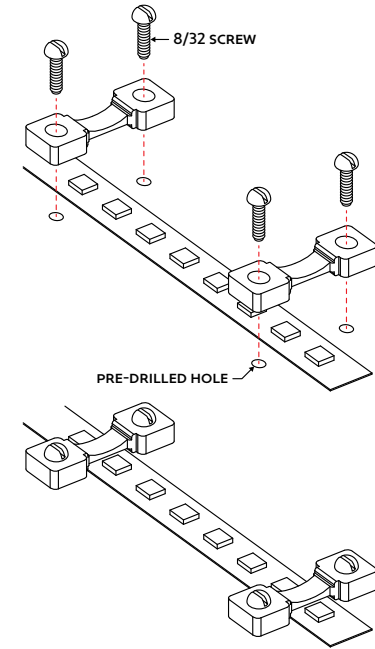

- 6 Always use a mounting clip at the very beginning and very end of each run.

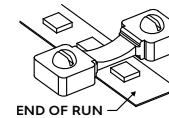



Perspective View

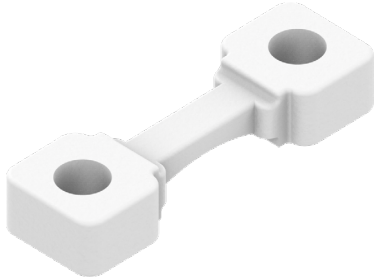

Assembled Dimensions



Wet Location

1 Measure area where lightstrip will be installed. Use a laser line to create a reference line along installation area, ensuring consistent alignment of mounting clips. Mark location where each mounting clip will be installed along reference line.

2 Remove adhesive backing from lightstrip and stick in place along reference line, ensuring lightstrip is securely mounted and free of twists, tangles, creases, bumps, or overlaps.

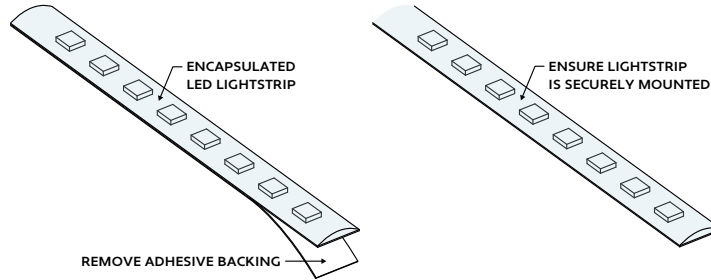

3 For Dry Locations applications, only use the mounting clip with the flat side facing down.

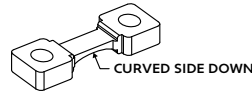

4 Use 1 mounting clip every 6", rounded up. Use 1 mounting clip every 4", rounded up if application is downward facing, outward facing, or vertically mounted. Lay mounting clips and pre-drill using an appropriate drill bit for surface material and screw size.

Recommendation: 8/32 x 1" screw.

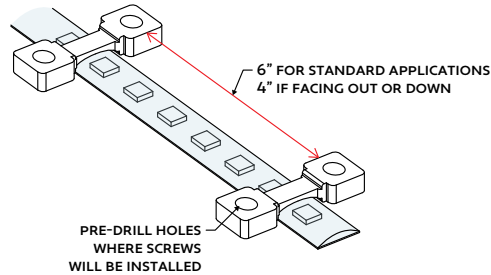

A8 Series | LED Tape ZUDA Tape - Mounting Clip (A8-ZUDA-TAPE-MCS)

5 Screw mounting clips to surface, securing lightstrip to surface.
Note: Do not install clips over LED diodes.

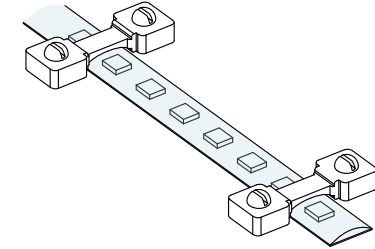
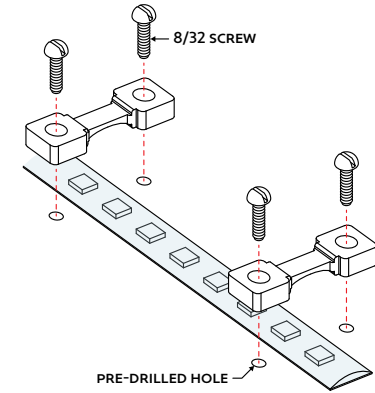

6 Always use a mounting clip at the very beginning and very end of each run.

